

# Paul Neuhaus

Paul Neuhaus GmbH  
Olakenweg 36 · D-59457 Werl

+49(0)2922 9721 0  
+49(0)2922 9721 9120  
info@neuhaus-group.de

<https://scm.paul-neuhaus.de/public/conformity/>



D | Montageanleitung • GB | Fitting instruction

**DE** Dieses Produkt enthält Lichtquellen der Energieeffizienzklasse <E>.

**GB** This product contains light sources of energy efficiency class <E>.

**FR** Ce produit comprend sources lumineuses de classe d'efficience énergétique <E>

**ES** Este producto contiene fuentes de luz de la clase de eficiencia energética <E>.

**HR** Ovaj proizvod sadrži izvori svjetlosti energetskog razreda <E>.

**HU** Ez a termék <E> energiahatékonysági osztályba tartozó fényforrások tartalmaz.

**IT** Questo prodotto contiene una sorgente luminosa della classe di efficienza energetica <E>.

**NL** Dit product bevat lichtbronnen van energie-efficiëntieklasse <E>.

**835809**

230V/50Hz~  
7x LED-Board 54V DC / 7,5W  
nicht wechselbar / not changeable

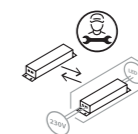
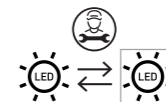
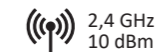

**LED** 7,5 W  
1.000 lm

**Light bulb icon** 60 W  
4.000 lm

**LED-Board icon** LED-Board  
25.000 h

**Tk** 2.700 - 5.000 K

**Light bulb icon** 15.000 x

**Light bulb icon** < 0,5 s

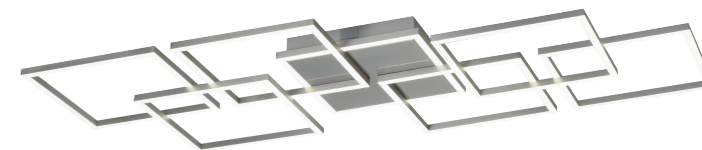

AAA, 1,5V

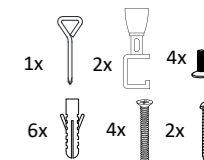

Inkl. IR-Fernbedienung  
Incl. IR remote control



# 1 | Montage / fitting

als Deckenleuchte  
as ceiling light

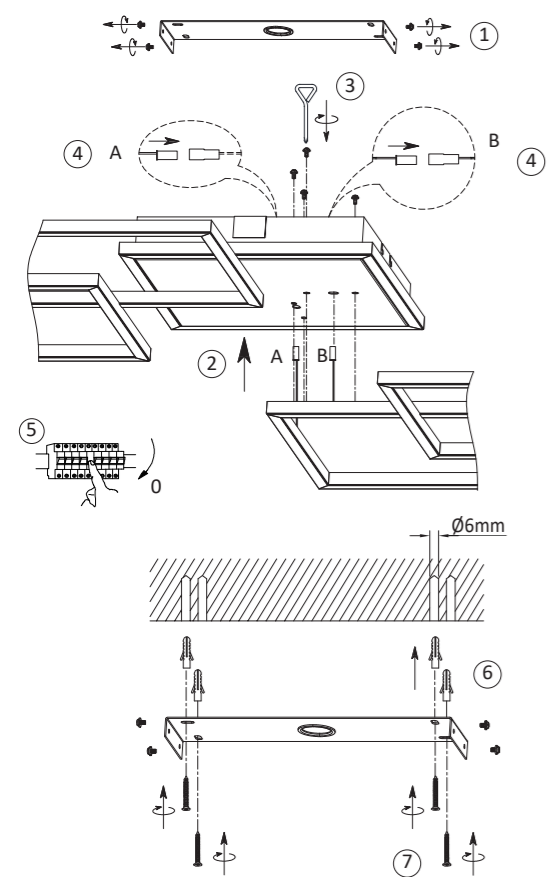

# 2 | Elektrischer Anschluss/ electrical c

230Volt/50Hz-Anschluss  
230 voltage/50 Hz connection

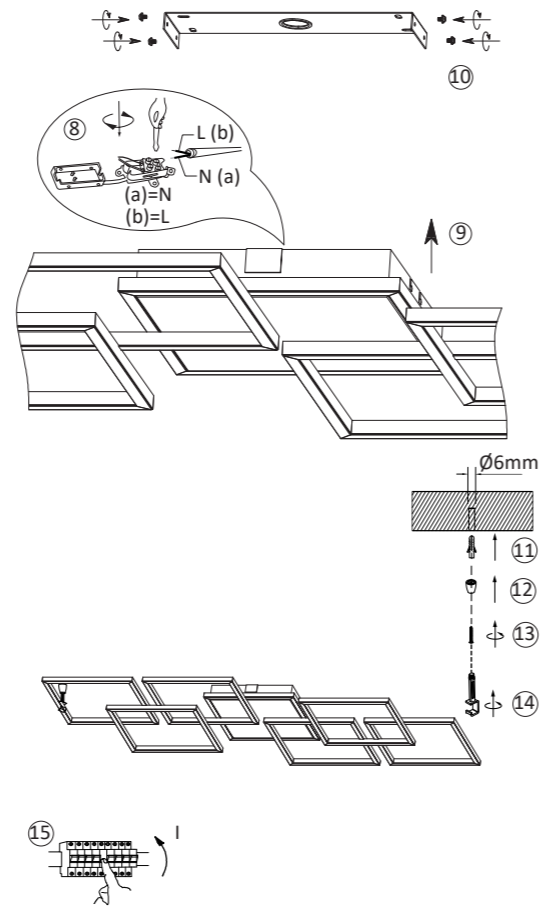

# 3 | Fernbedienung / remote control

Siehe Q-Fernbedienungsanleitung  
See Q-remote control manual

