

2888-3765

Versionsnummer:

04.2022

Naturholz kann sich werkstoffbedingt verziehen. Durch das Montieren ziehen sich Teile wieder plan.

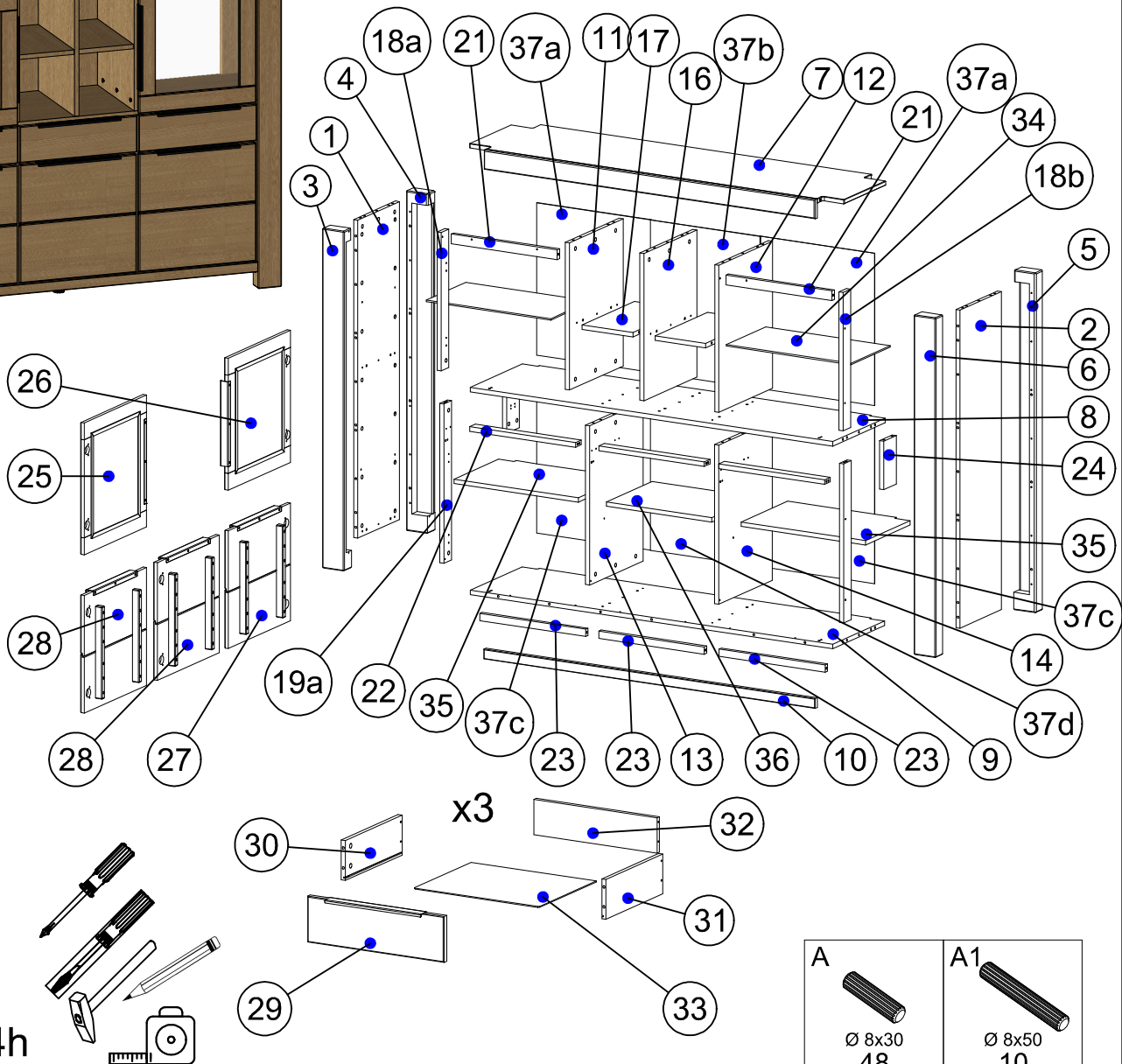
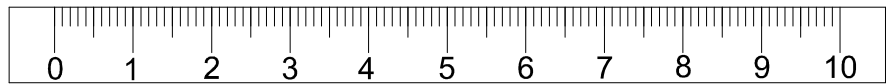

B 134	D 104	D1 30	C Ø 4x16 8	E Ø 6,3x13 10	F 10	G Ø 4x30 4	G1 Ø 4x35 6	H Ø 3x16 110	I2 8
J1 Ø 5x13 72	J Ø 5x9 16	K 12	L Ø 6,4x50 15	M 8	N 1	O OL3/OR3	P 40	T Ø 3x16 6	I1 12

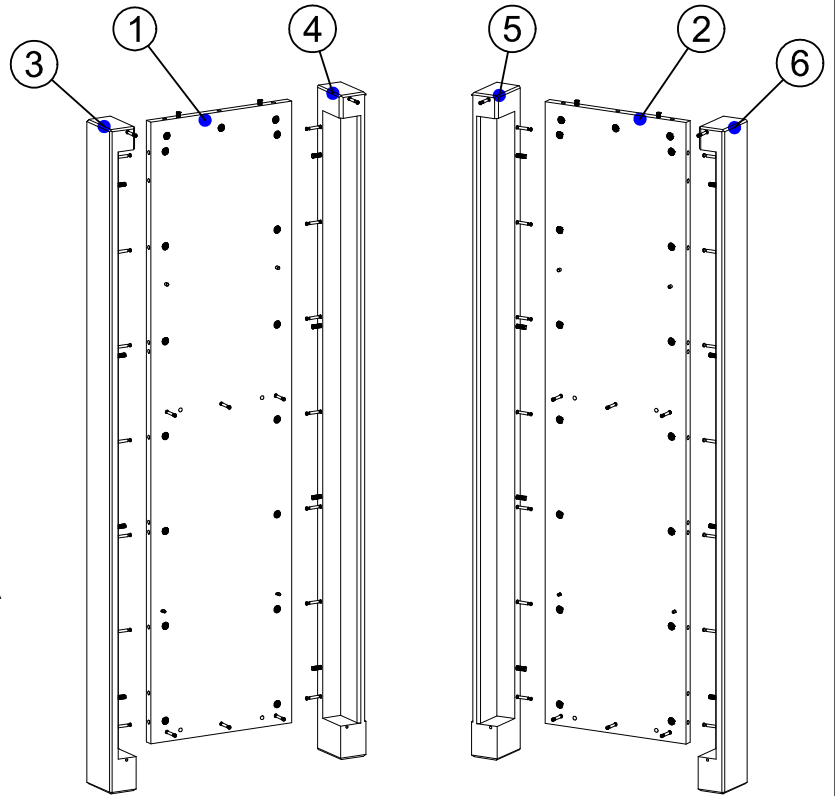
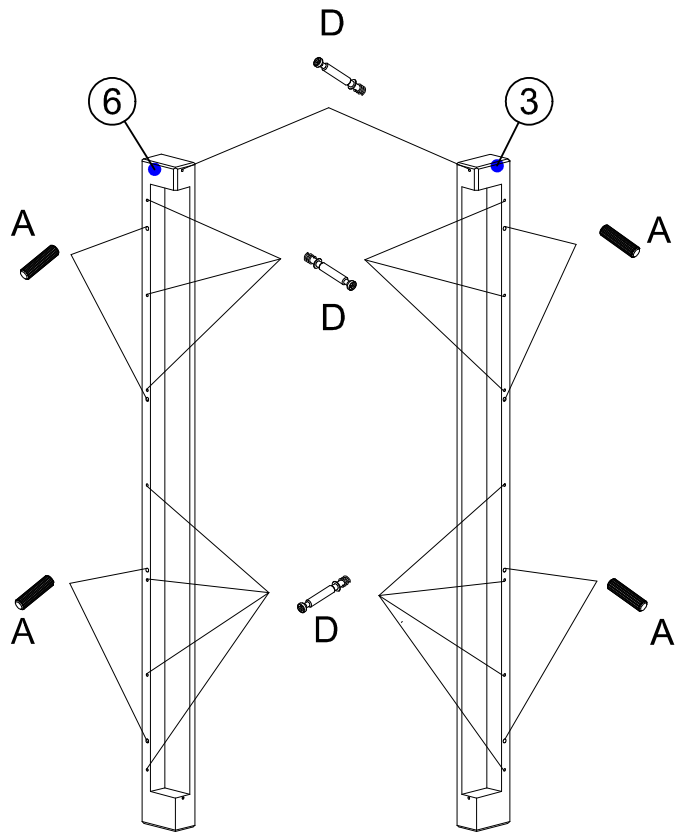
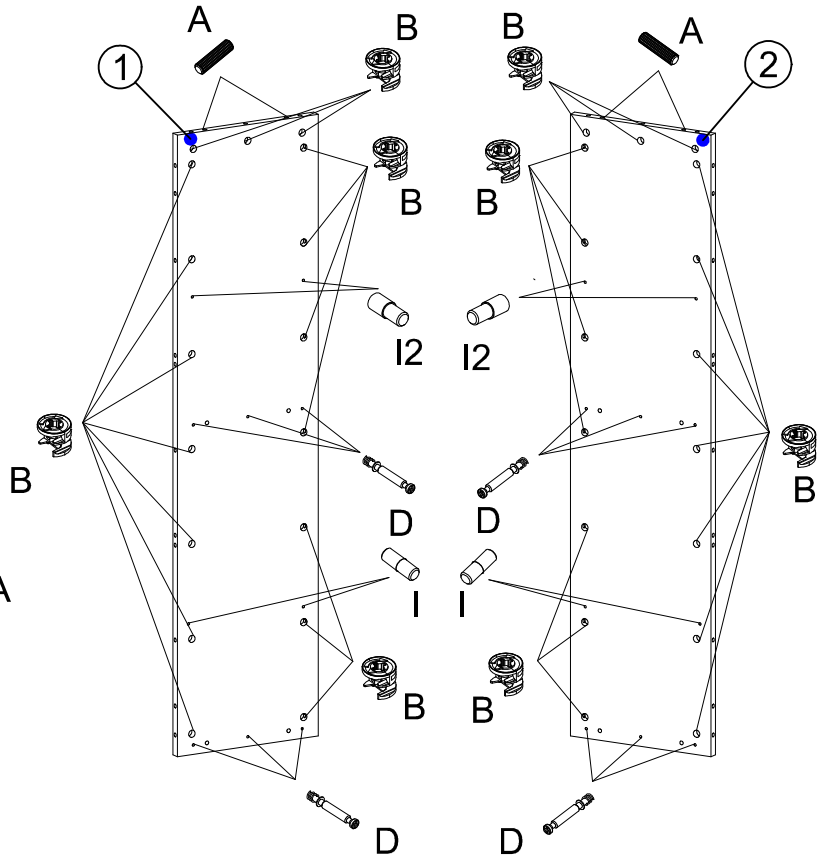
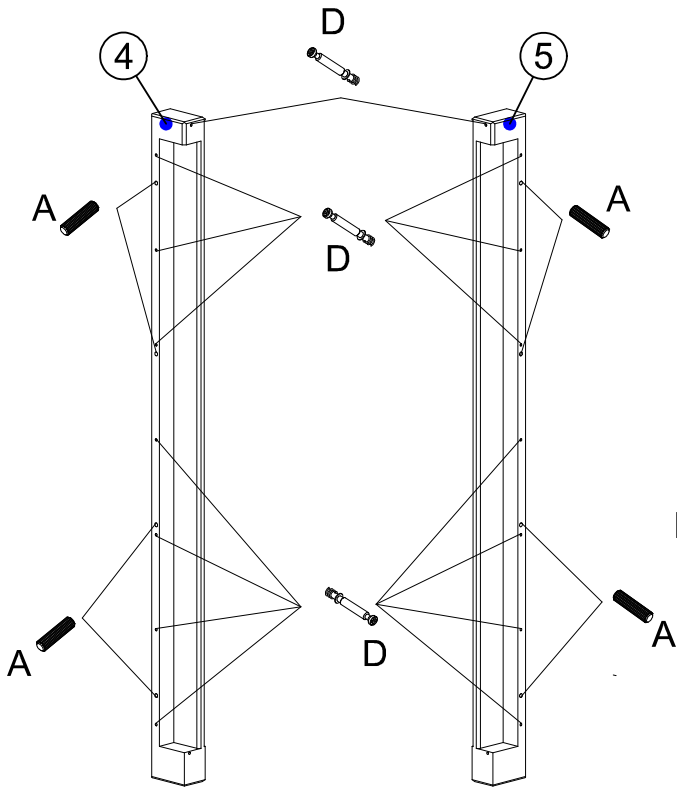

I

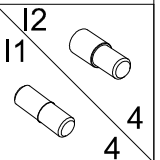
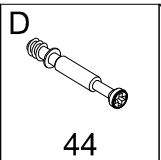
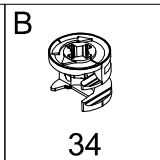
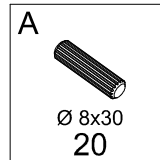
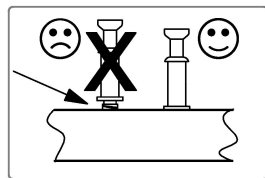

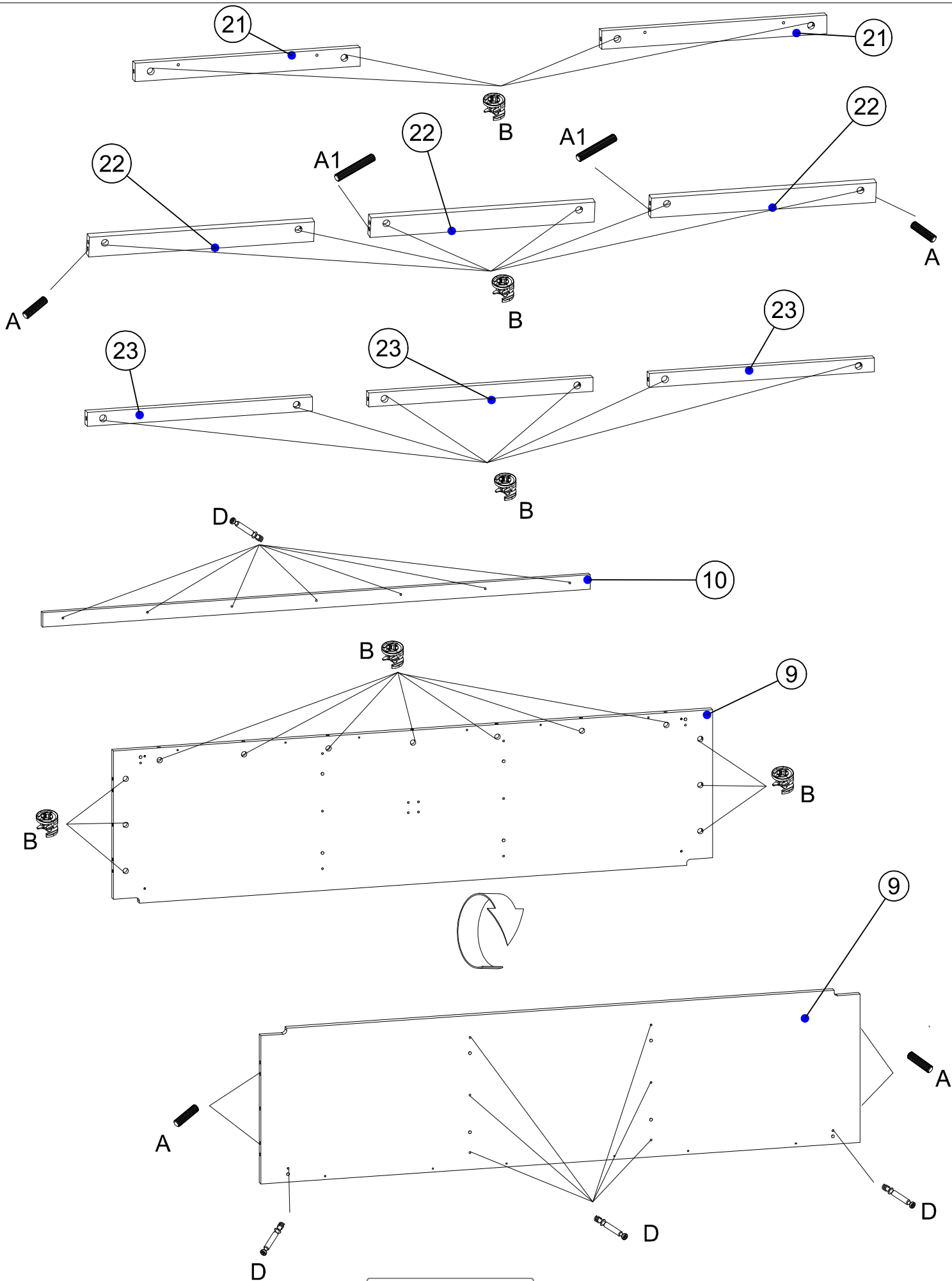

II

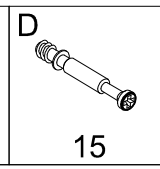
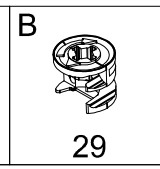
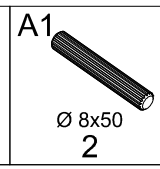
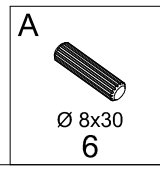
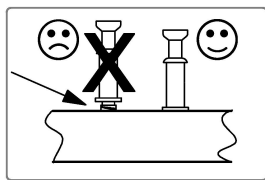

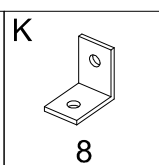
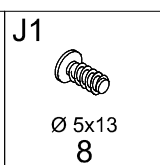
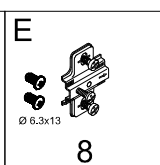
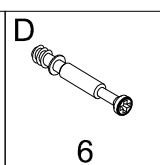
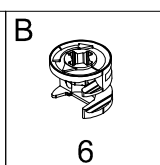
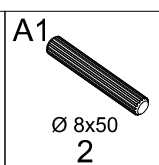
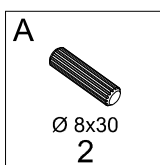
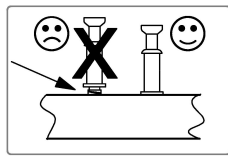
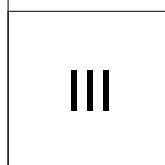
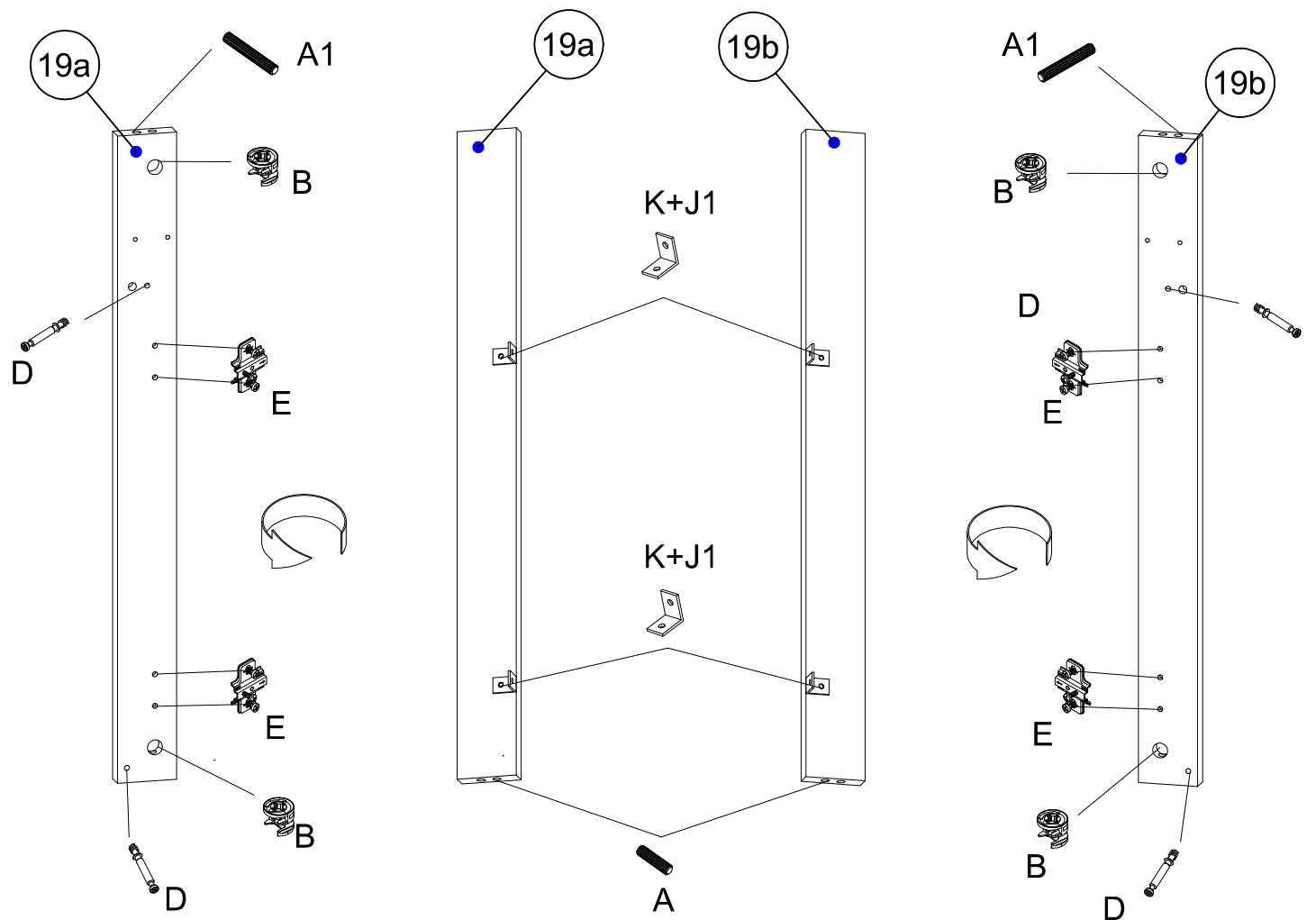
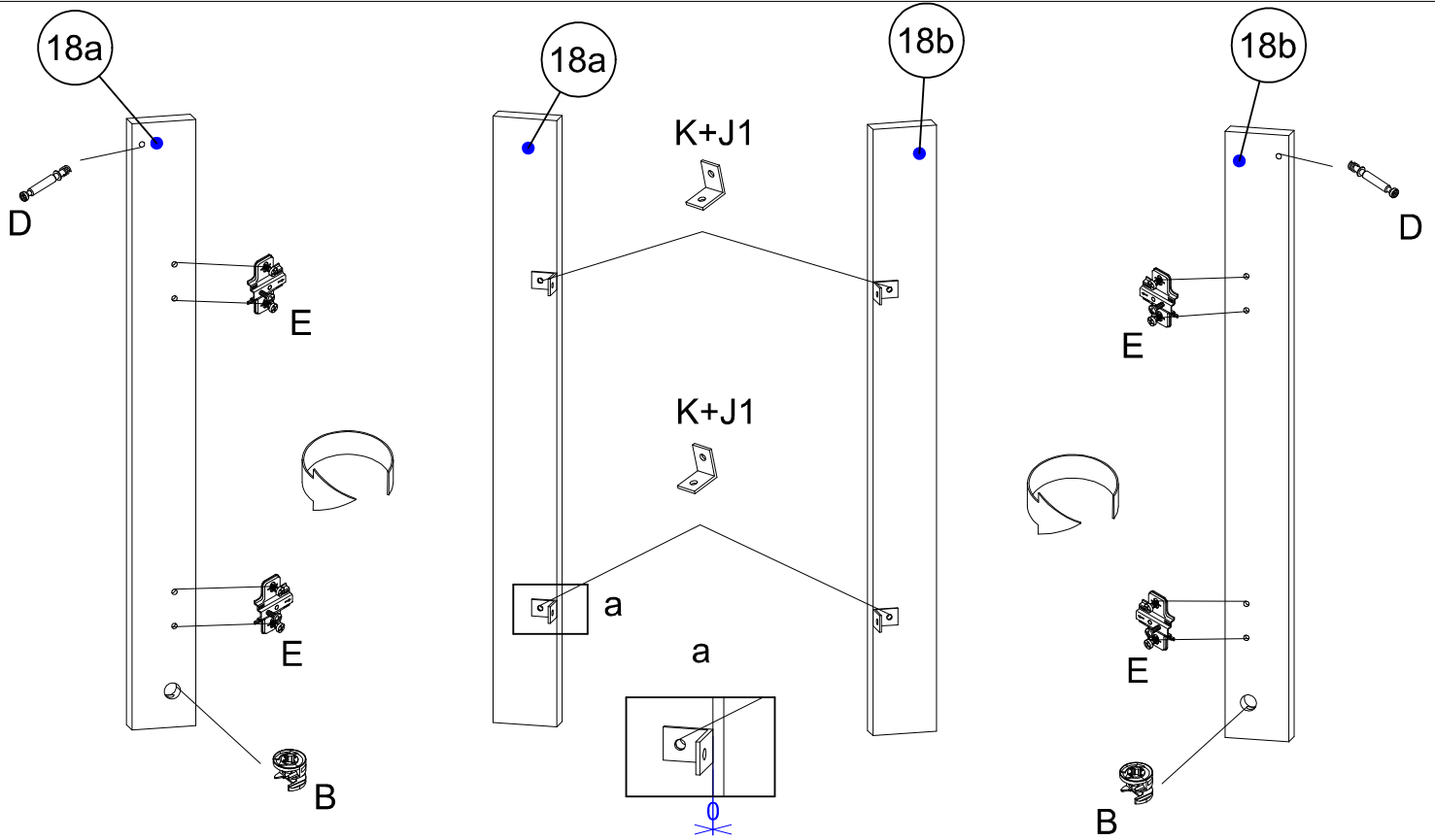

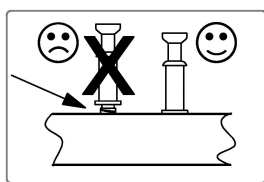
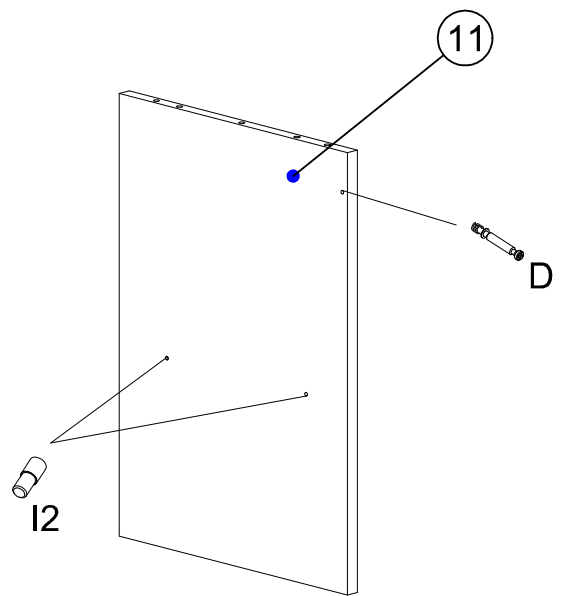
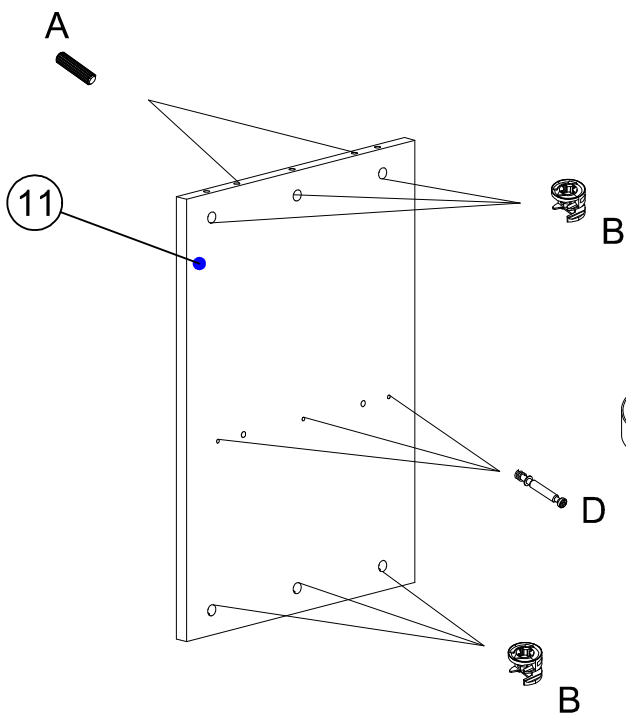
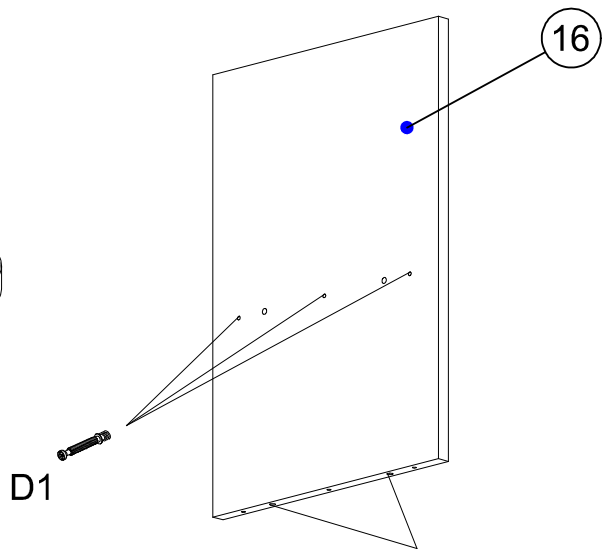
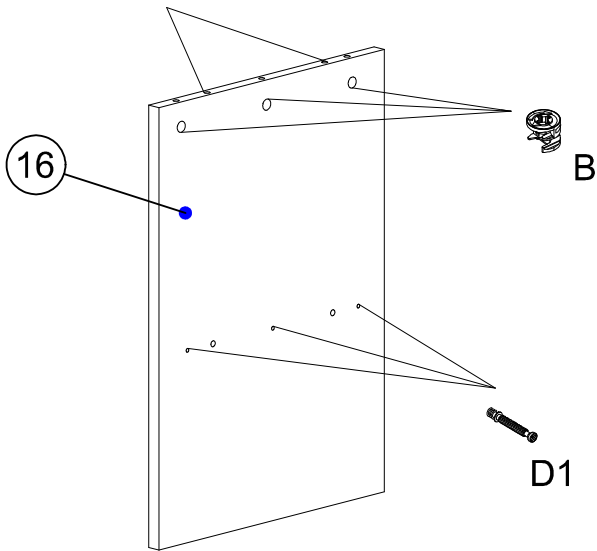
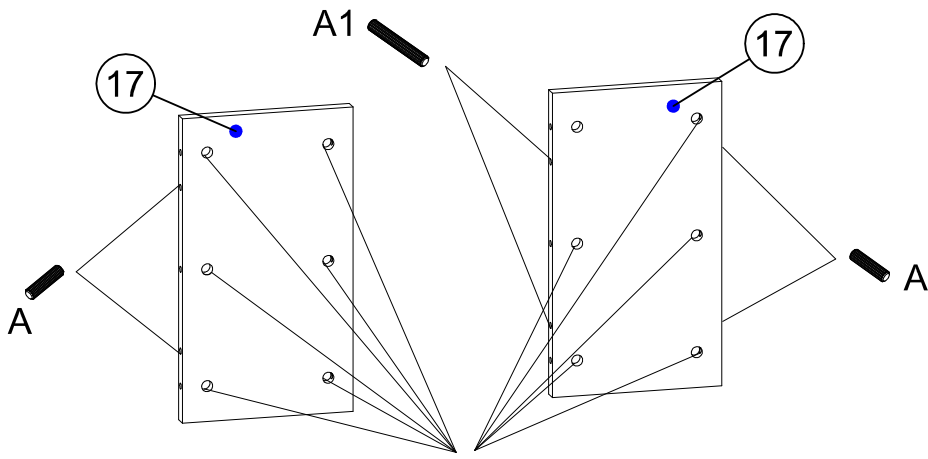

IV

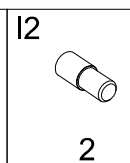
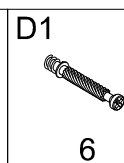
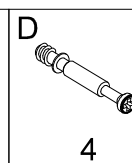
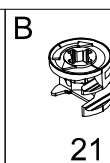
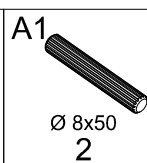
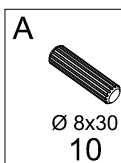

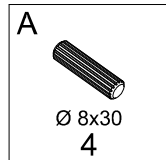
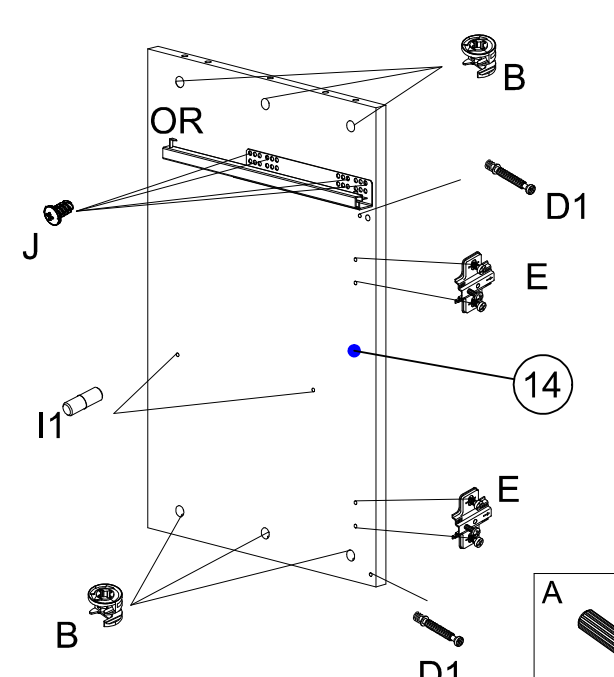
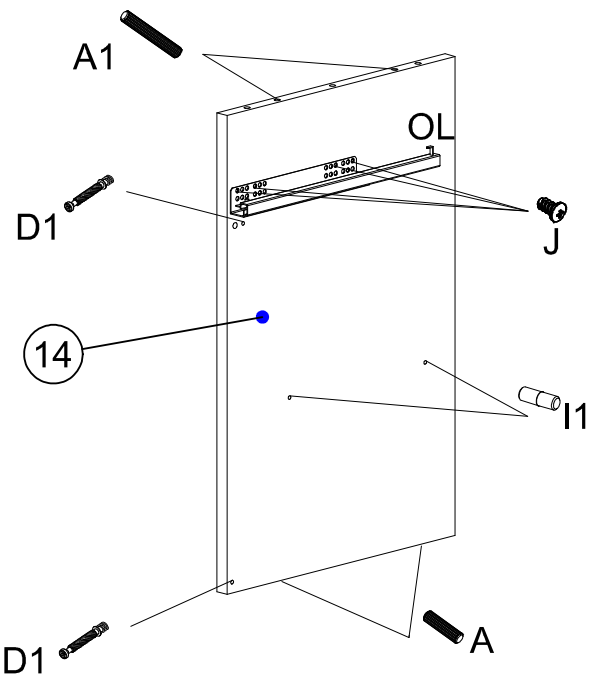
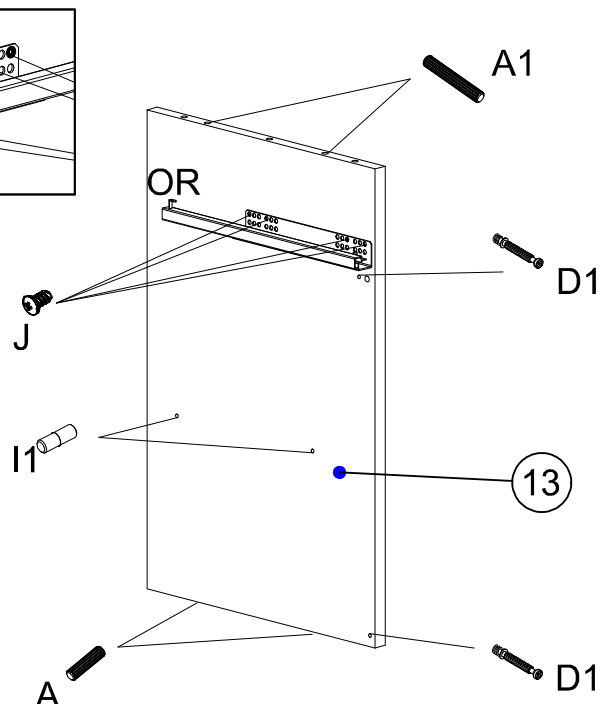
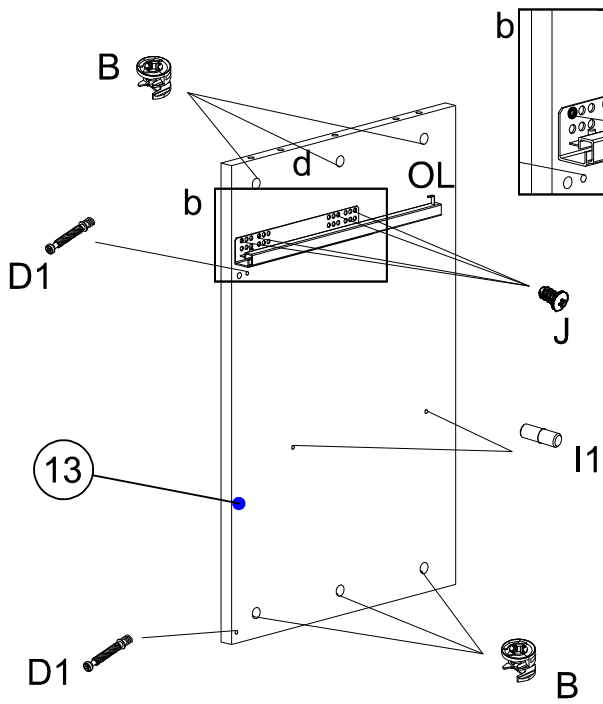
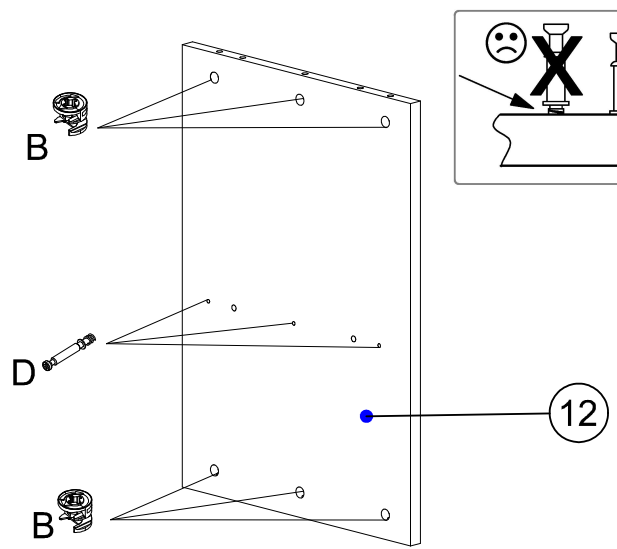
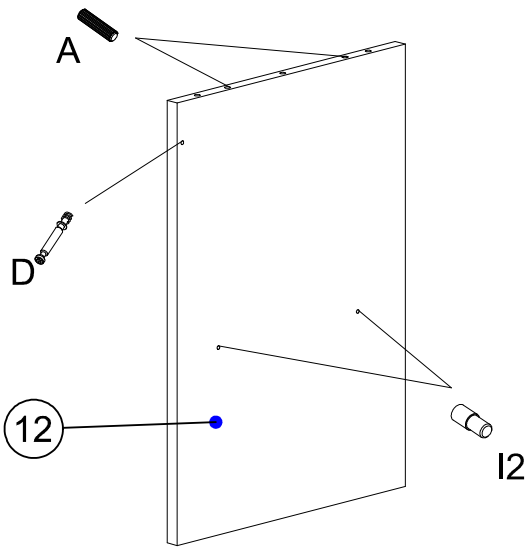

V

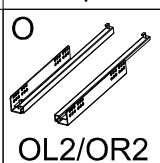
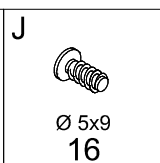
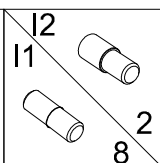
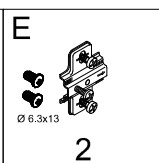
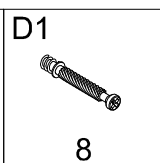
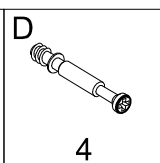
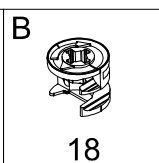
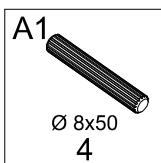

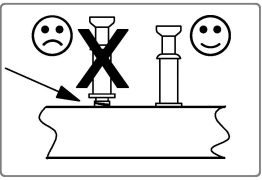

24

B

24

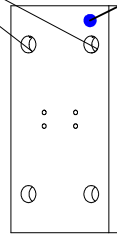
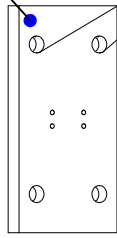

8

A

D1



D1

D1

A

D1

8

D1

B

D

D1

D

B

24

24

8

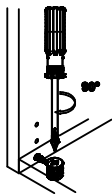

VI

A



4

B



10

D



4

D1



16

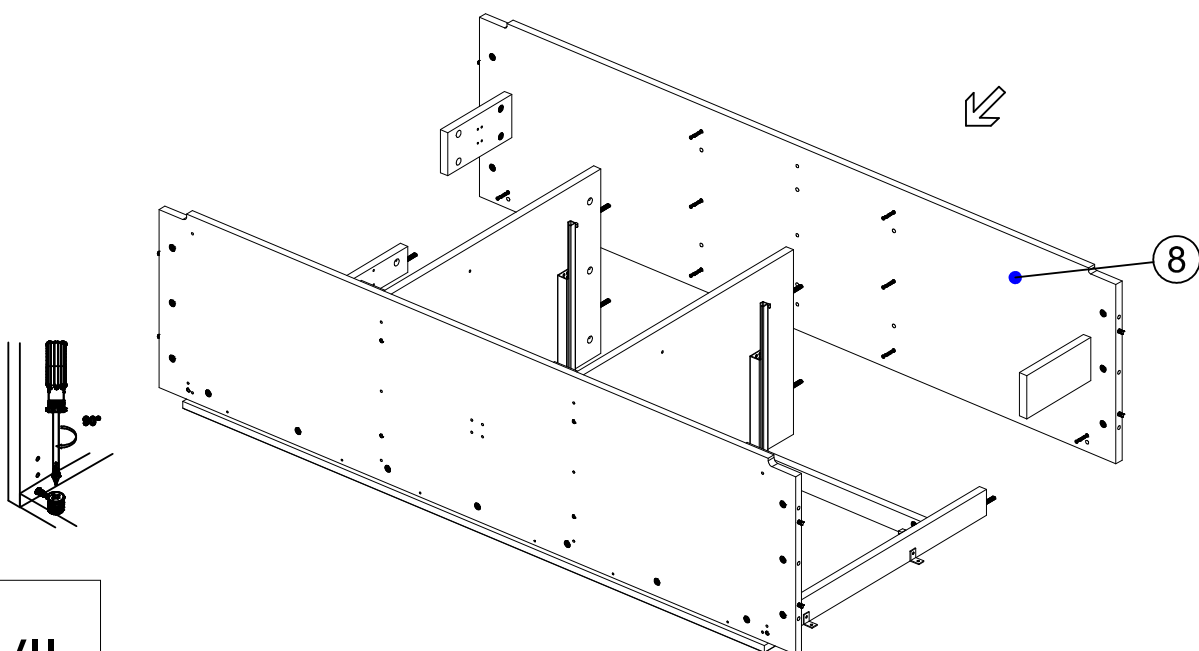
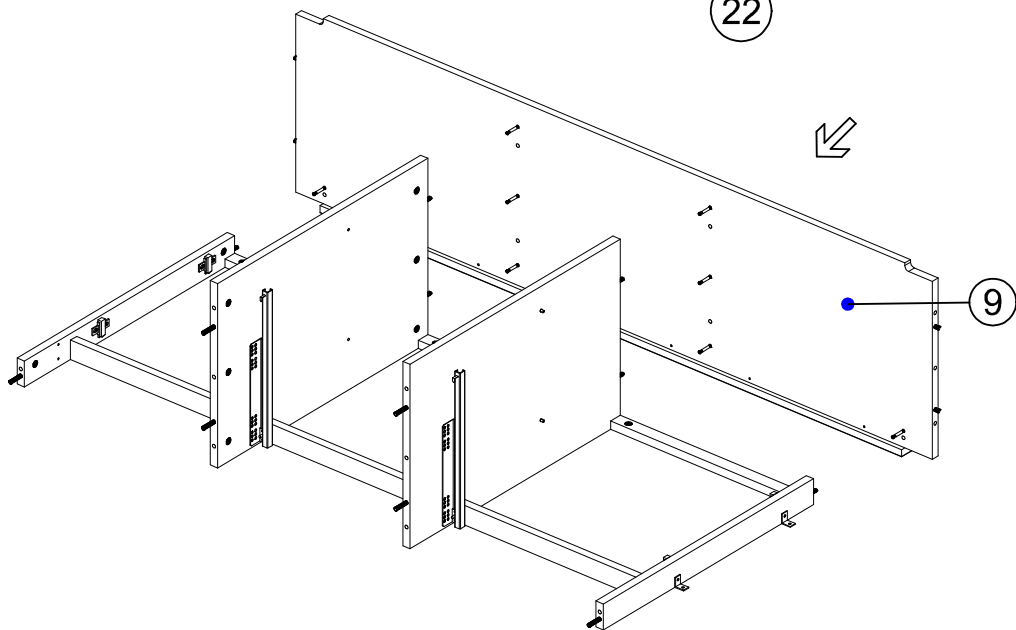
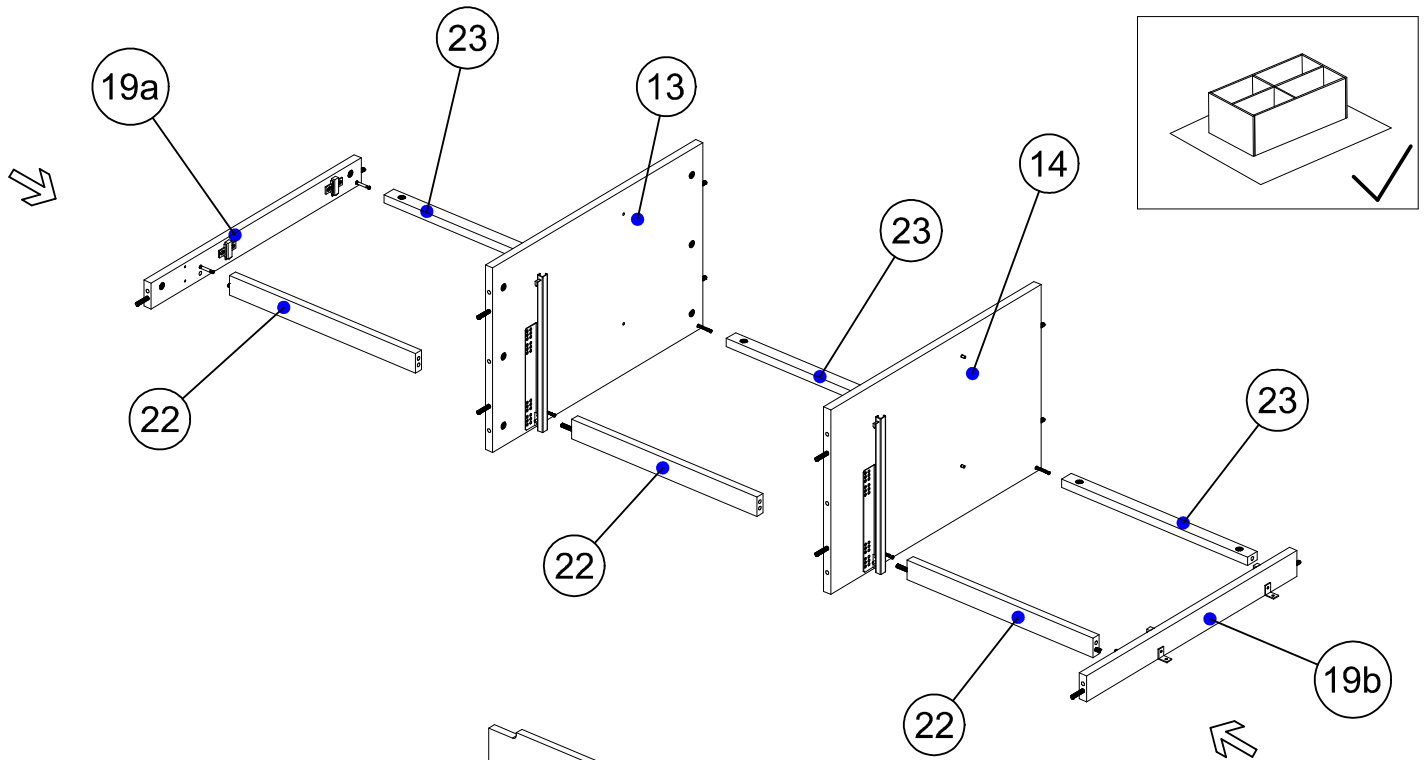

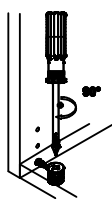
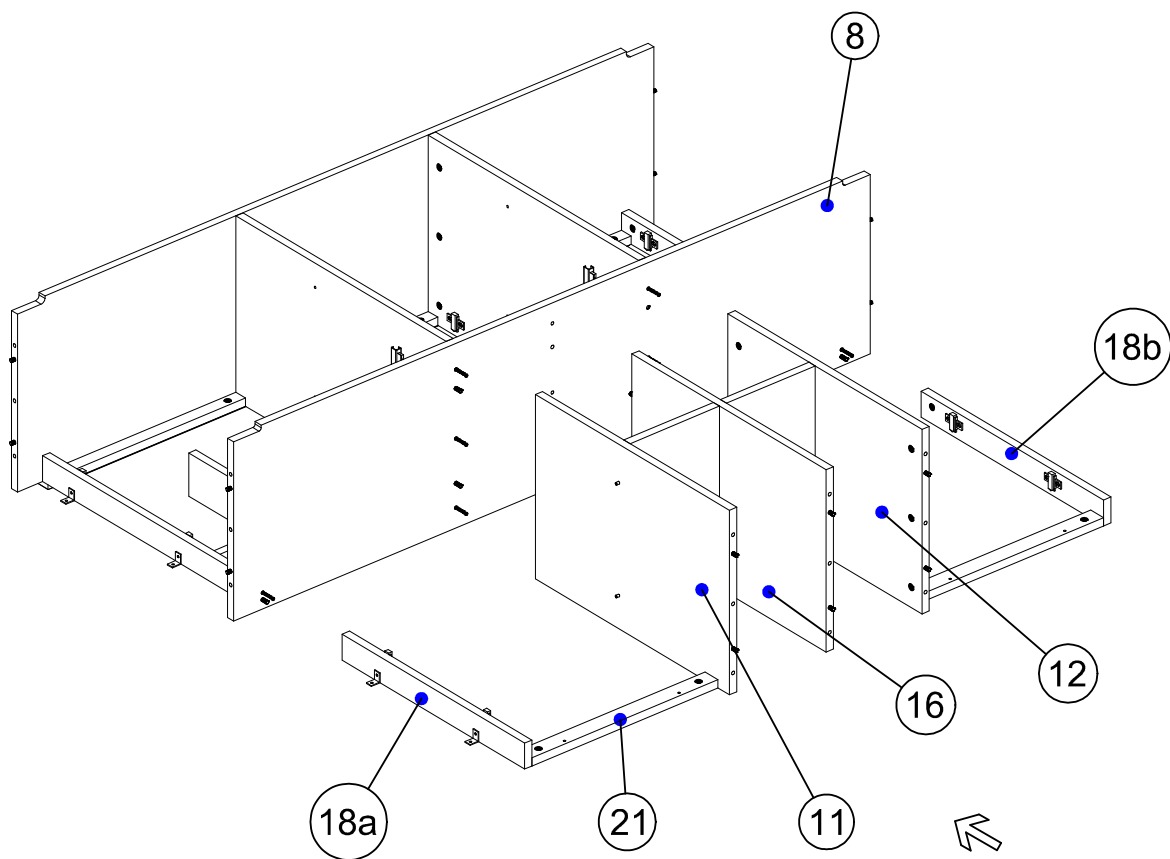
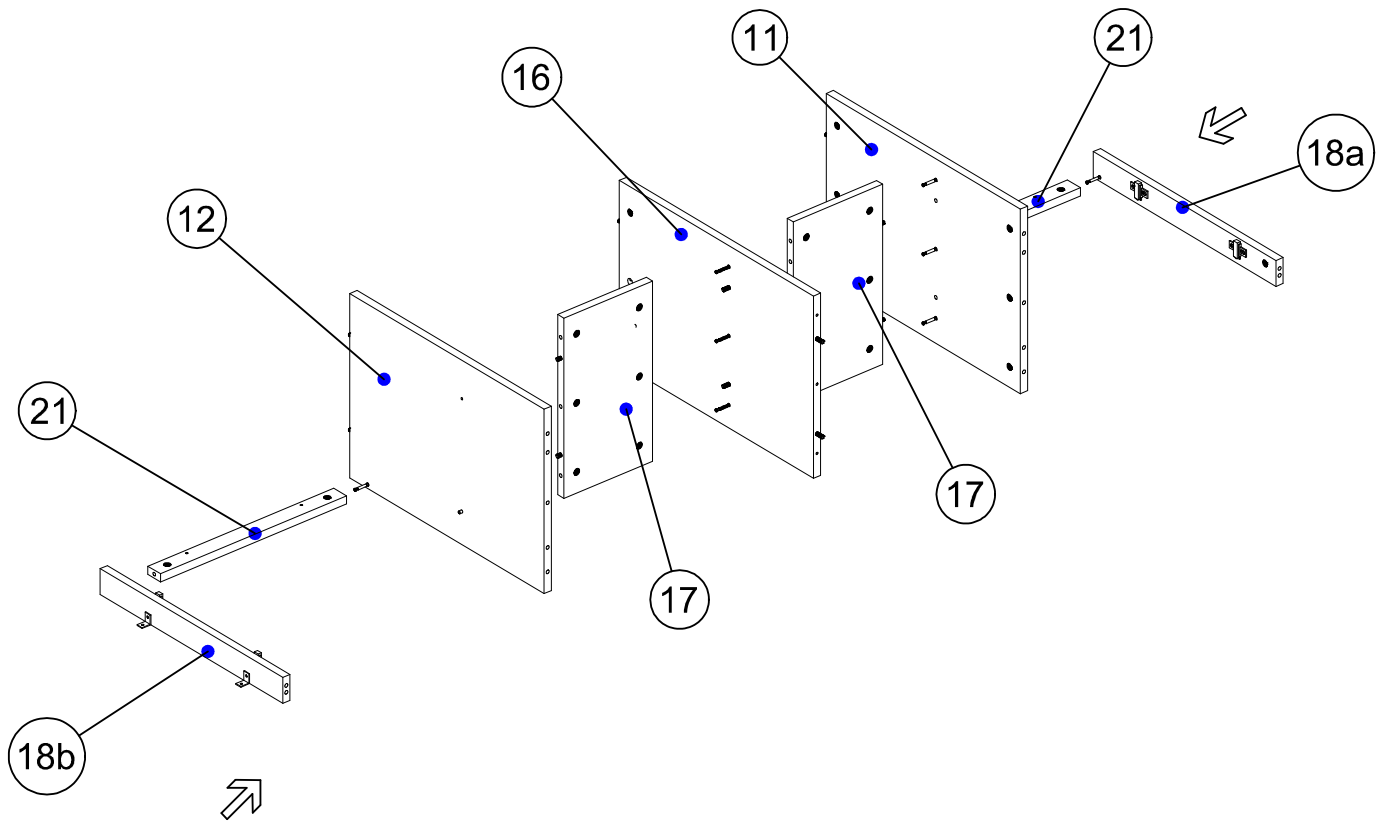

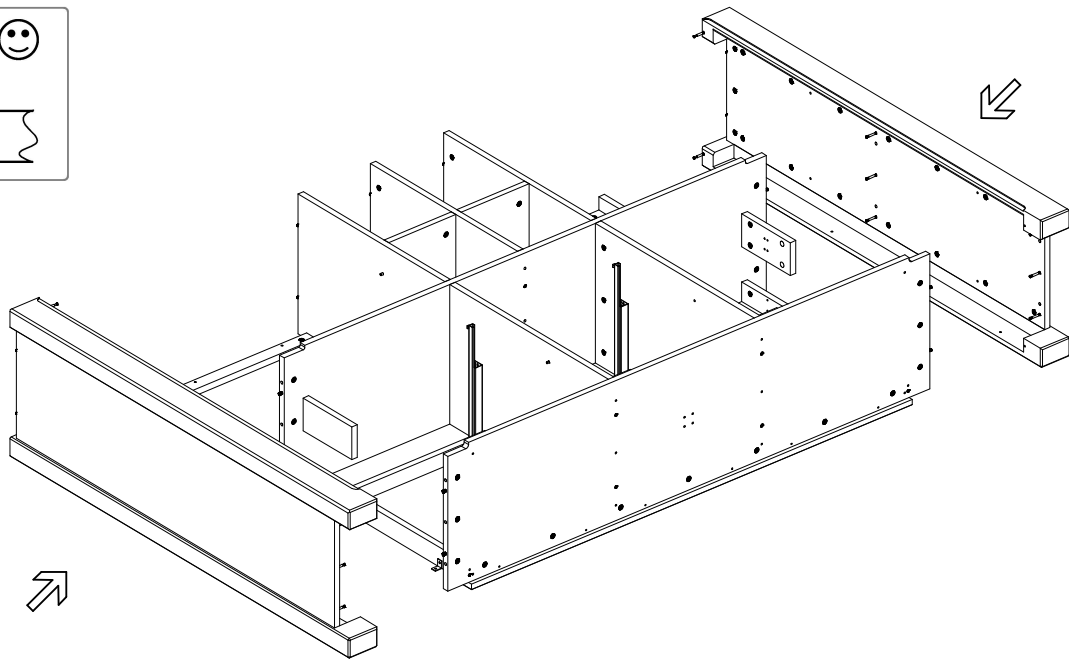
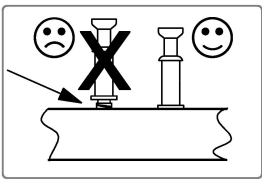

IX

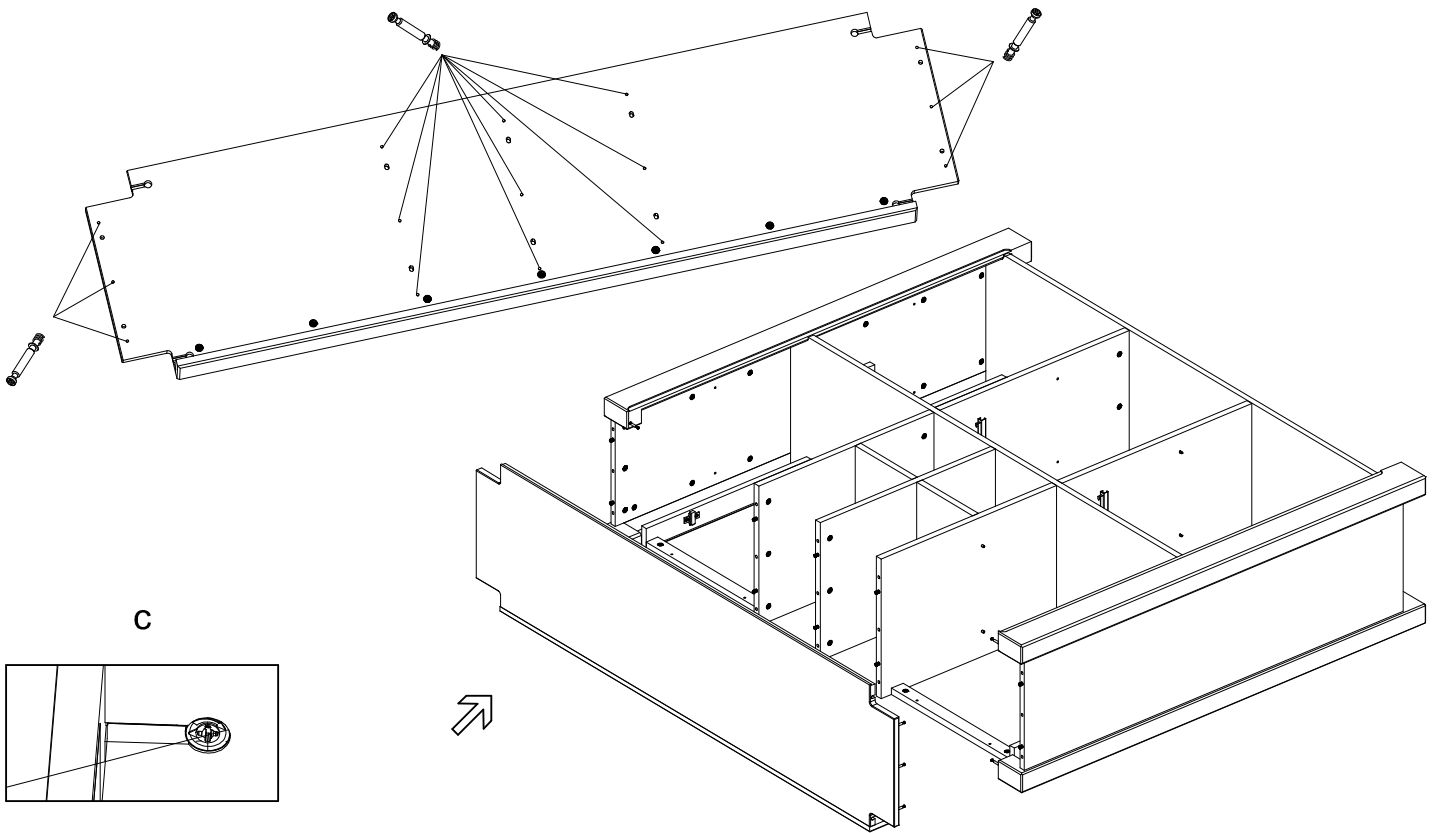

C

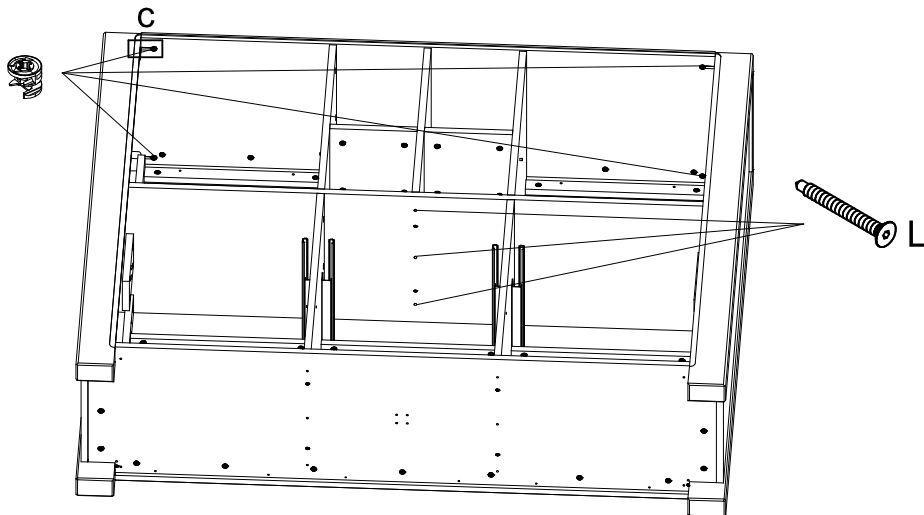
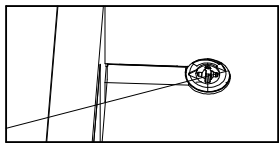

C

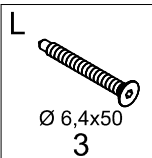
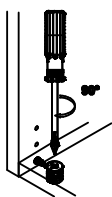

Ø 6,4x50
3

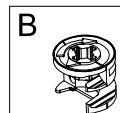

4

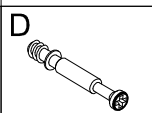

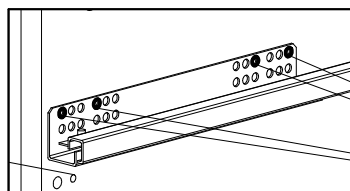
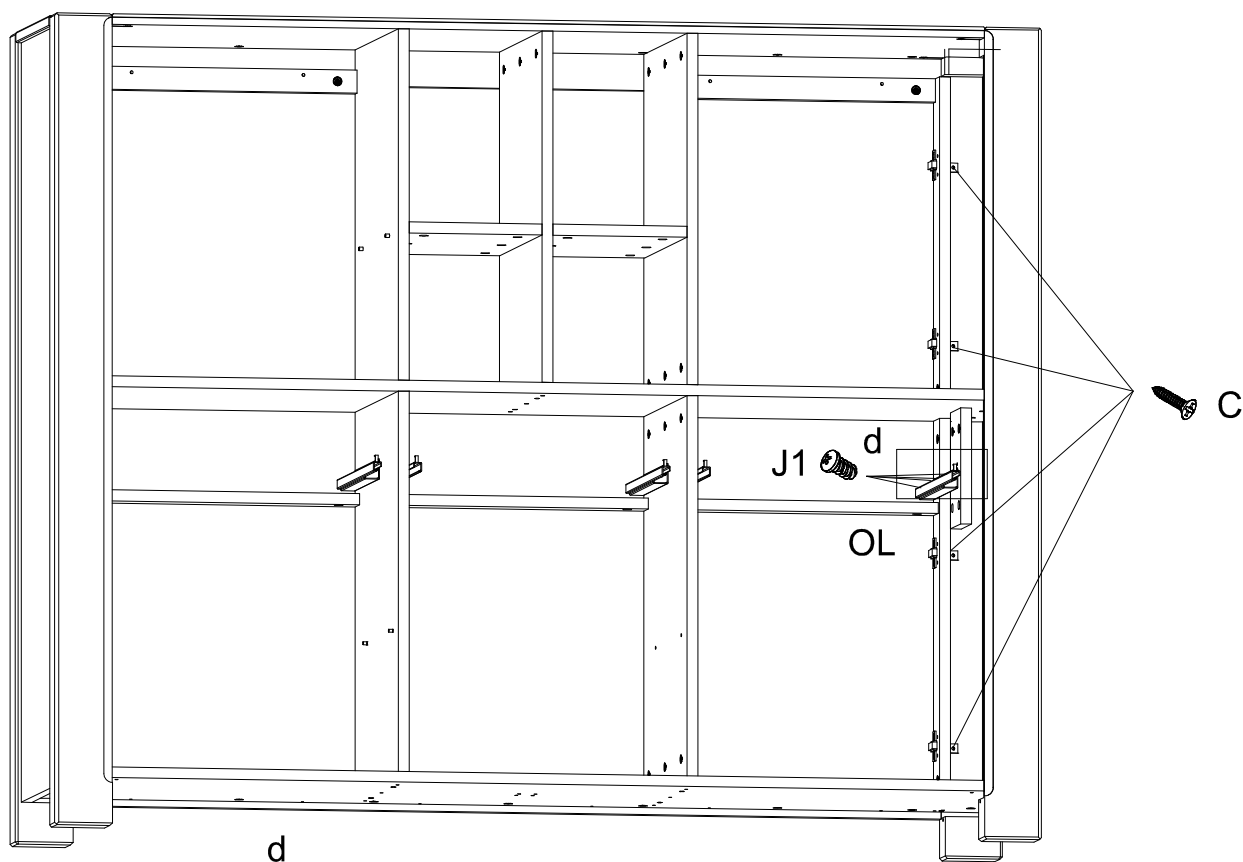
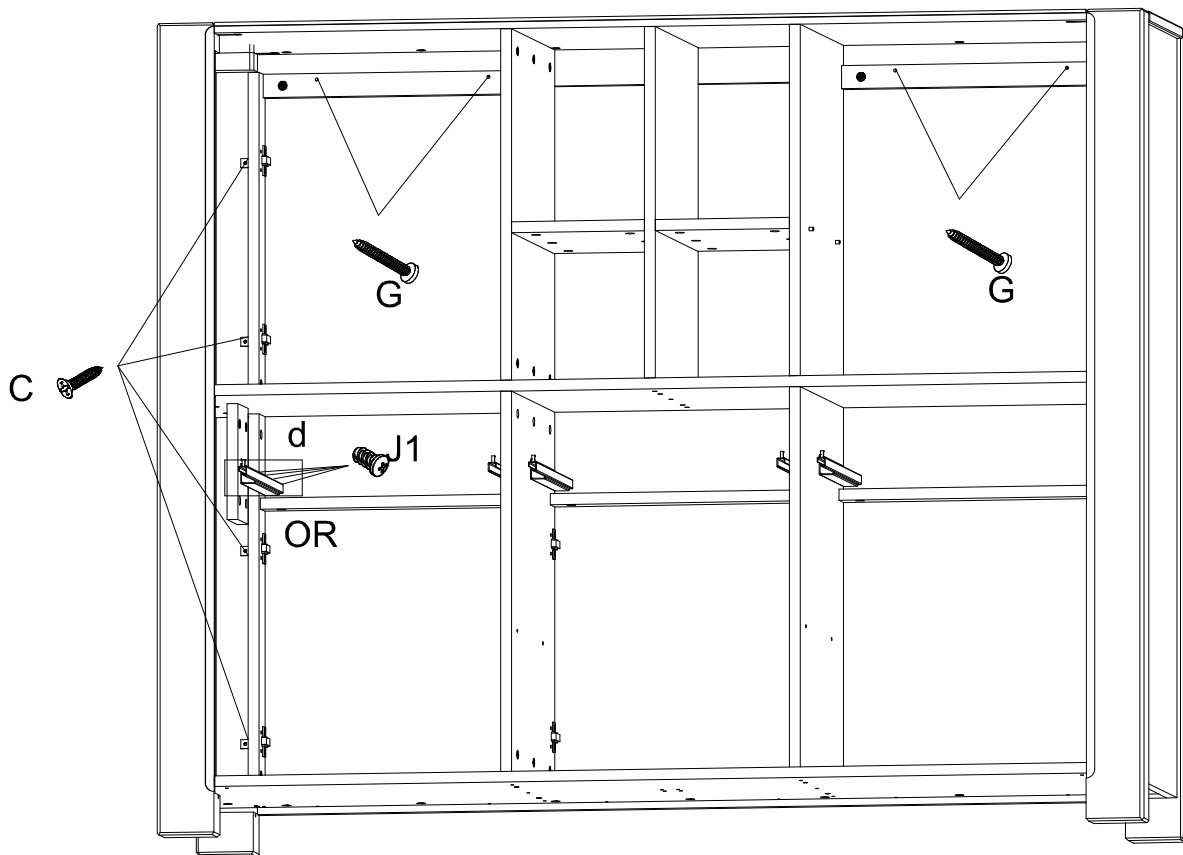

15

X





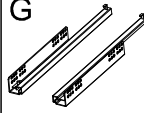

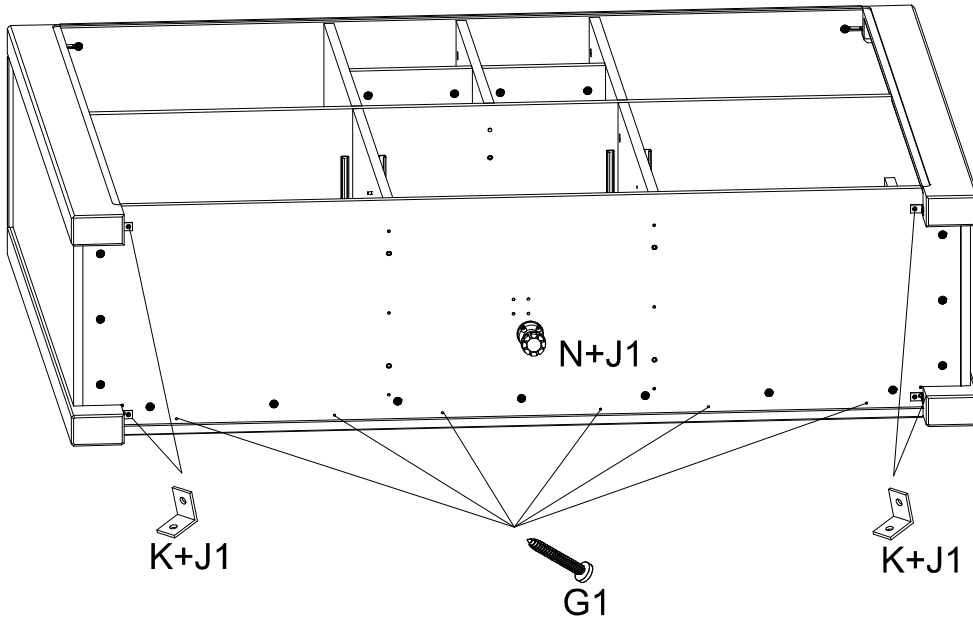
XI

<p>C</p>  <p>Ø 4x16 8</p>	<p>G</p>  <p>Ø 4x30 4</p>	<p>J1</p>  <p>Ø 5x13 8</p>	<p>G</p>  <p>OL1/OR1</p>
--	---	--	--



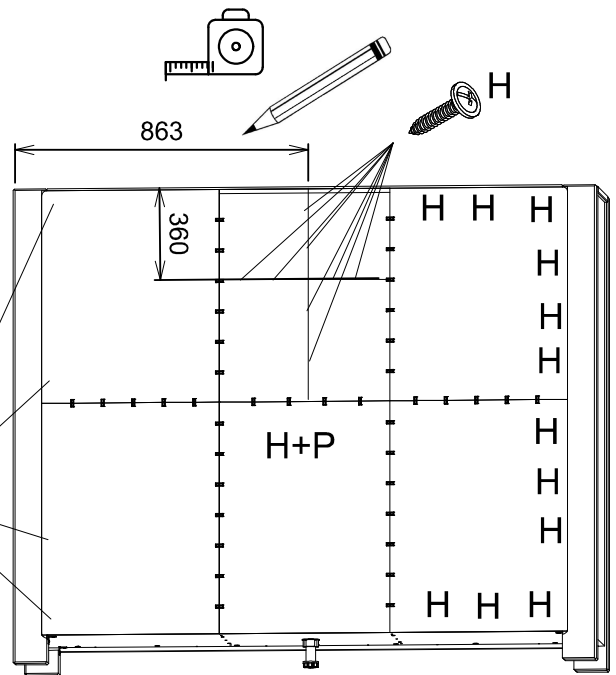
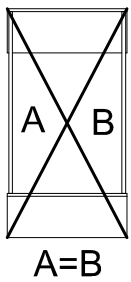
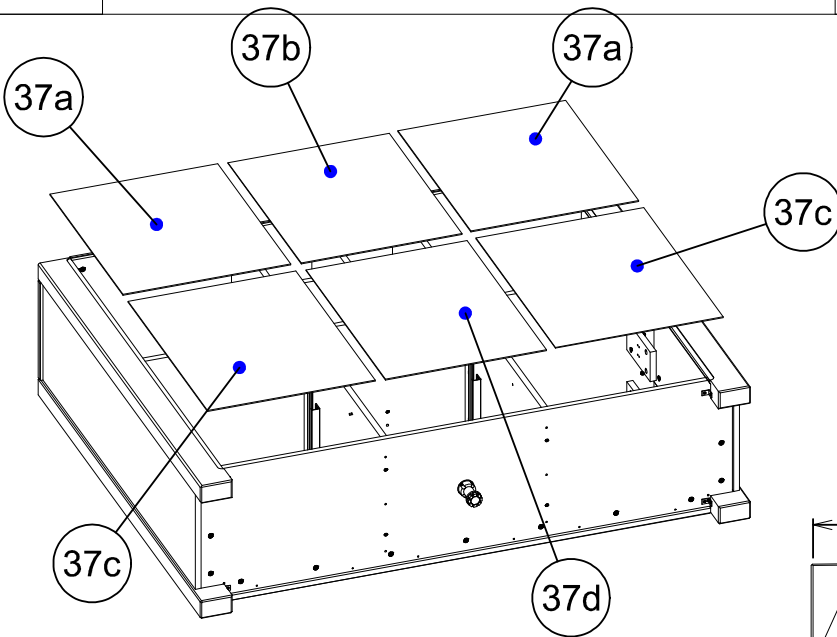

XII

<p>G</p>  <p>Ø 4x35 6</p>	<p>J1</p>  <p>Ø 5x13 12</p>	<p>K</p>  <p>4</p>	<p>N</p>  <p>1</p>
--	---	--	--



XIII

<p>H</p>  <p>fi 8x30 98</p>	<p>P</p>  <p>40</p>
---	---

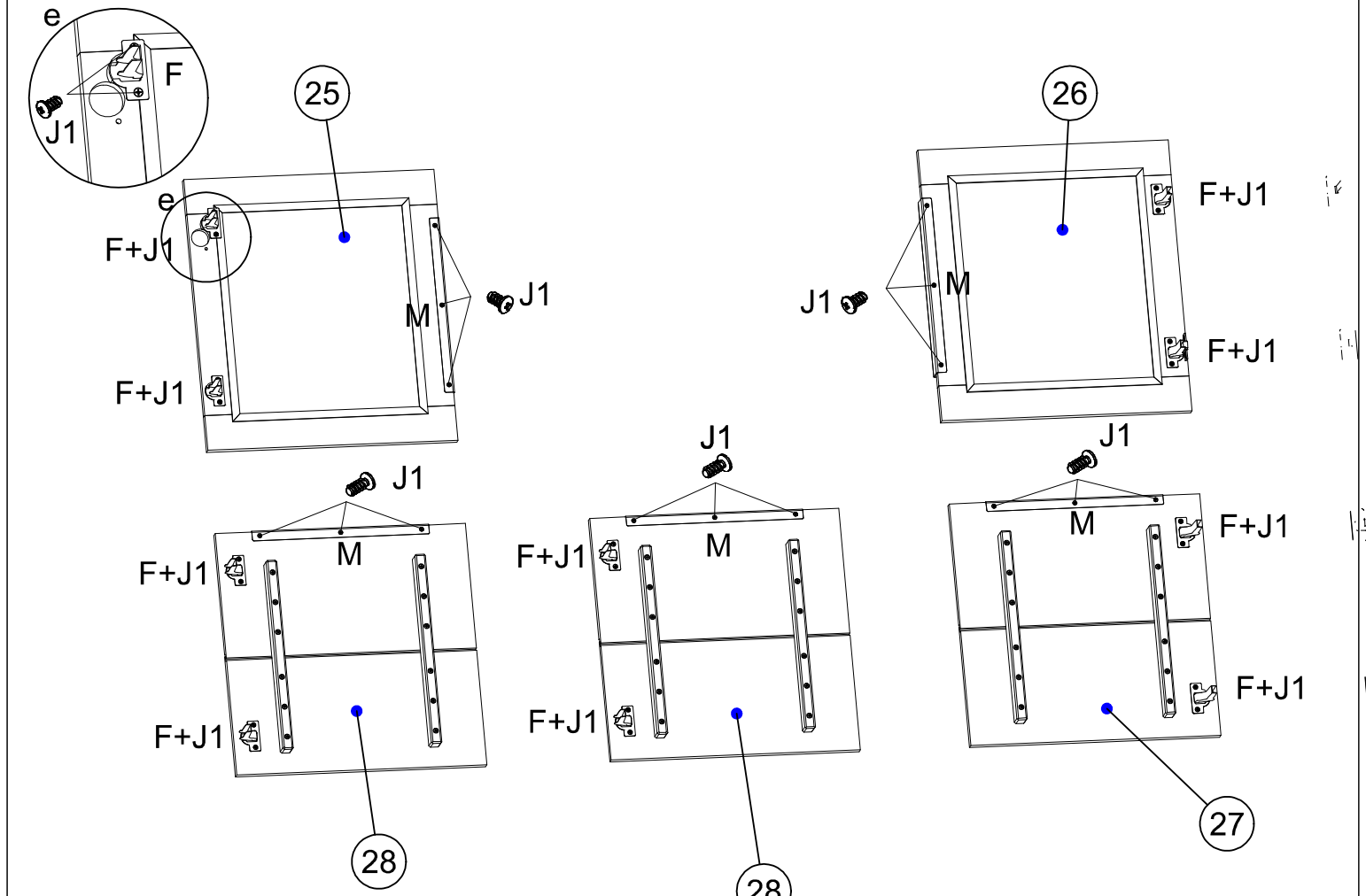
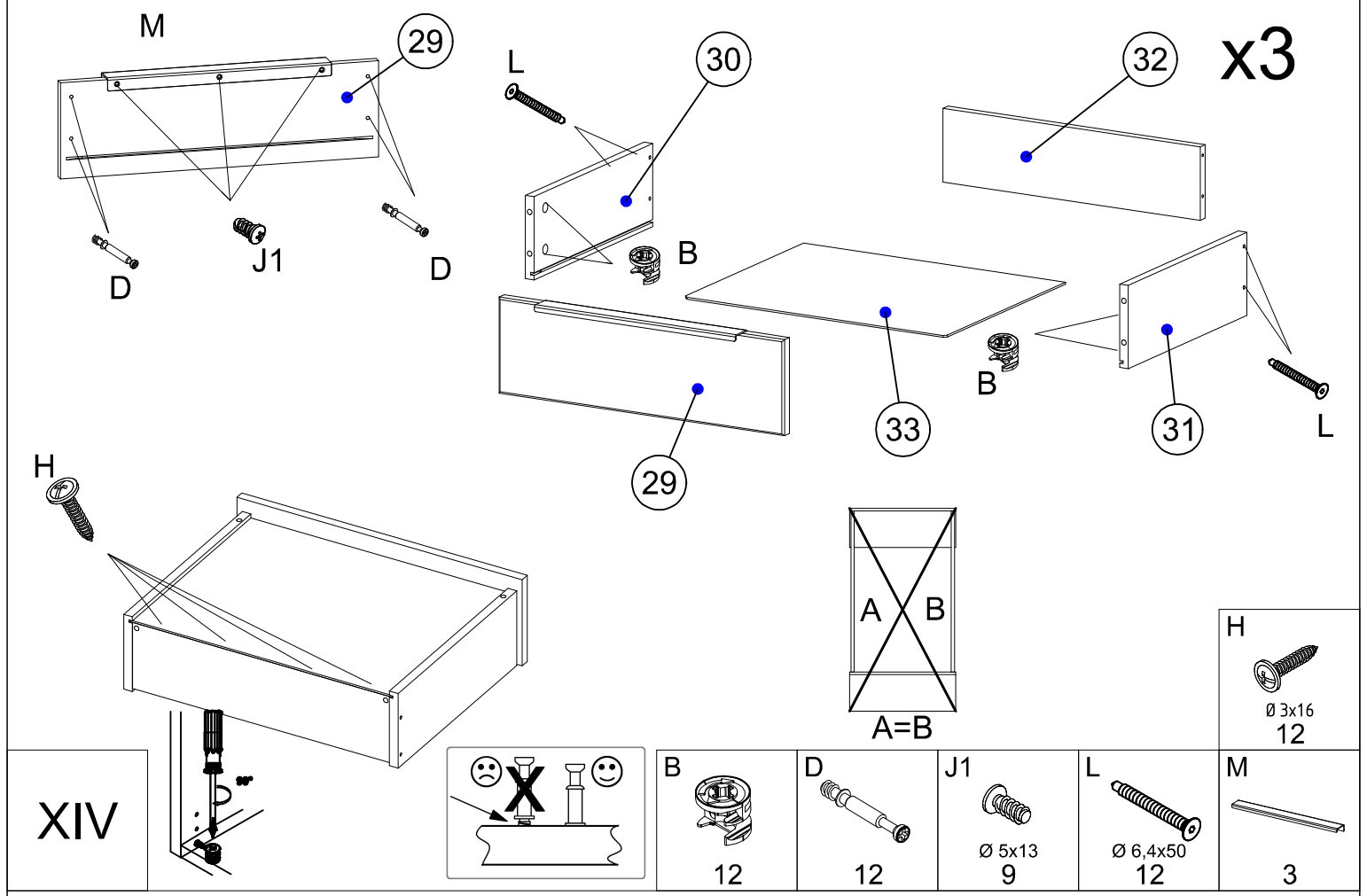

x3

