

ASSEMBLY and USE INSTRUCTIONS EAN code 4041104039608**General safety instructions for product use and operation****Caution:**

1. Read the following instruction thoroughly before unpacking the luminary and starting its installation.
2. PLS note that all kind of work within electrical appliances shall be proceeded only by a professional electrician.
3. PLS follow the instruction and keep it for the future needs.
4. Whenever you give the luminary product to the third person always include the corresponding instruction.
5. The product is only intended/allowed for connection to 220-240V~ 50Hz AC Voltage and only with the light sources as indicated in the part called „Technical Parameters“
6. Avoid any damaging or clamping of cable. Cables must be laid in such a way that they do not run over sharp edges and are not crushed or subjected to tensile loads.
7. Please do not look directly into light while switching on or operating the illuminator to avoid eye damage.
8. If there are any electrical components or parts broken, have it replaced or repaired only by an authorized electrician.
9. This luminary is intended only for an indoor installation (IP20) in a private home.
-not intended to be installed in the surrounding where the explosion and/or fire hazard exists
-keep the luminary far away from easy flammable substances and/ or objects.
- do not expose the luminary towards strong impact of warmness, humidity and/ or dust.
10. The luminaire is designed according to protection class II and does not require a protective conductor connection.



Warning: Before you start any kind of work within the electrical appliance, you must cut off the current supply at first. Pull out the fuses or switch the current off assuring nobody else switch it back on. Danger of electrical shock!!

Cleaning and Maintenance.

1. PLS cut off the electrical supply and let the luminary get completely cooled before you start cleaning it.
2. PLS clean the luminary with a dry soft cloth.
3. ATTENTION! The acrylic lampshade must not be wiped with alcohol or alcoholic cleaning agents.

Repairs

Warning: PLS note that all kind of work within electrical appliances shall be proceeded only by an authorized electrician.

Technical Parameters:

220-240V~50Hz, 1 x LED(whole lamp) 18Watt,1400lm-3000-6000K

220-240V~50Hz, 1 x LED-Board (only) 17Watt,2600lm-3000-6000K

This product contains a light source of energy efficiency class <D>.



Replaceable (LED only) light source by a professional.



Replaceable control gear by a professional.

| | |
|----------------|---------------|
| LED | 17 W |
| | 2.600 lm |
| | 18 W |
| | 1.400 lm |
| t | 20.000 h |
| T _k | 3.000-6.000 K |
| | 10.000 x |
| | <2 s |

The CE-conformity declaration to the product is available on our homepage: www-h-p-i.de under point "Produktinfo".

Assembly instruction

1. PLS remove any packaging material from the product and its parts.
2. PLS put the all the delivered parts together step by step, following below given drawing and text.

Waste Disposal of the electrical appliance!

If you decide to get rid of the product one day, be aware that many components are made of valuable raw materials and can be recycled and reused. Never dispose any electrical appliance to the dustbin, but bring it to your Electrical Waste Collecting Plant.

LOT-Nr.: KT28419

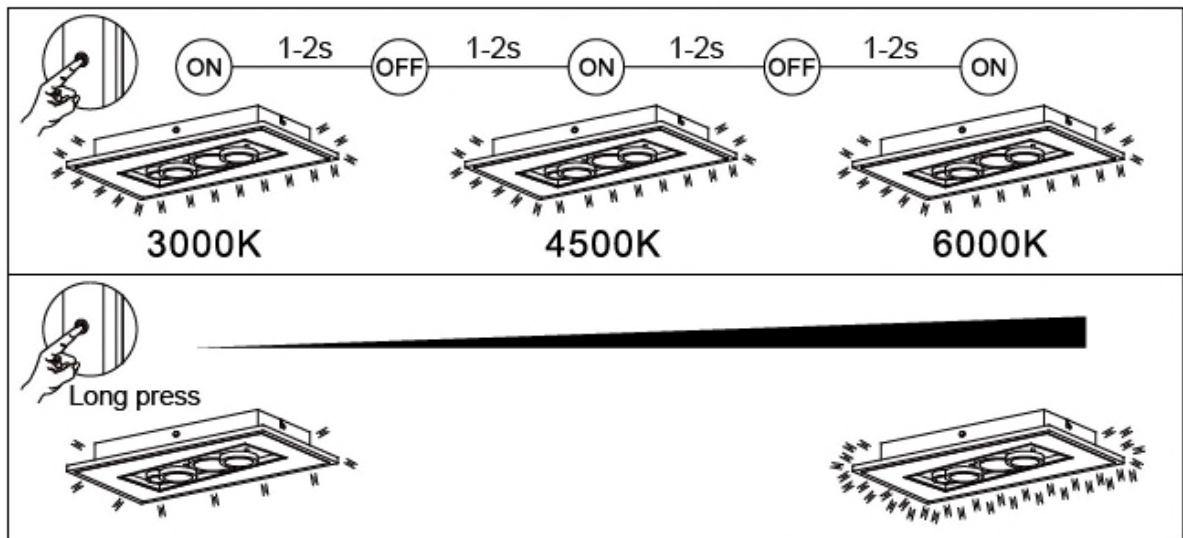
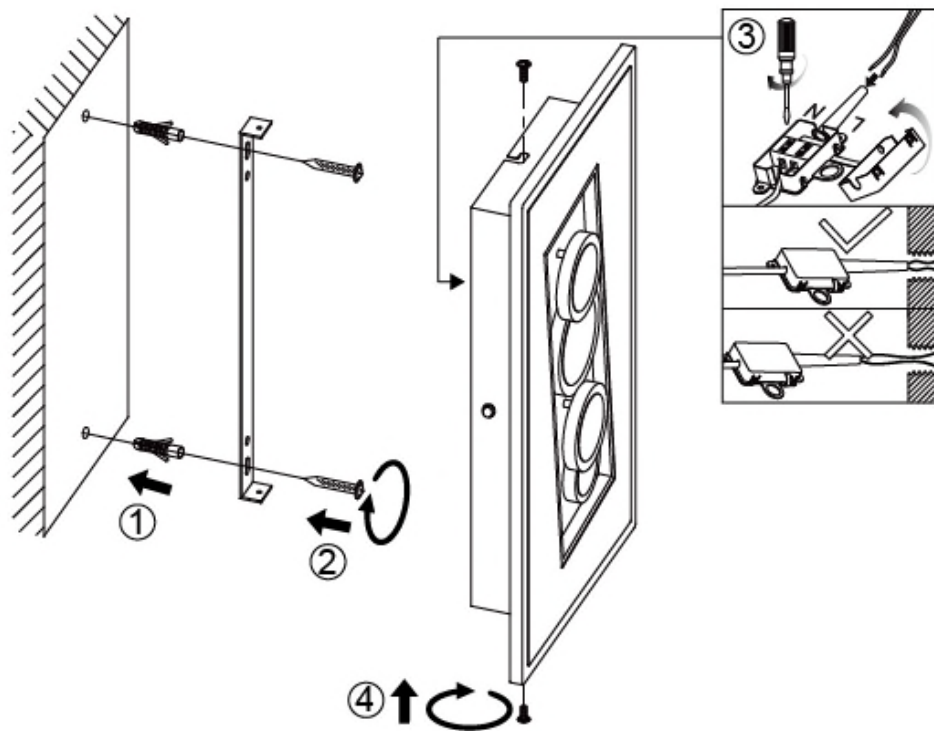

This light has a memory function.

When you turn on the light, the color temperature and brightness of the unit are stored in the last setting.

1+2. On the wall, select the location where the light will be installed later. Drill 2 holes in the wall using a drill to match the opening on the bracket and attach 2 ceiling dowels. Fix the bracket to the wall by tightening the two (2) screws.

3. Connect the cables: Connect the power supply to the terminal strip according to the markings **L: live,**
N: neutral.

4. Install the lamp on the wall bracket. Tighten the screws and fix the lamp to the mounting plate.

The colour temperature of the lamp can be controlled by switching the switch on housing. as follows:

- a. 1 x on , it will be switched to a bright “3000K”.
 - b. 1 x off and within 1 sec. On again, it will be switched to a bright “4500K”.
 - c. 1 x off and within 1 sec. On again, it will be switched to a bright “6000K”.
- Long press and hold to make stepless dimmable.

Producer/Importer:

Home Product Import GmbH

Graf-Zeppelin-Straße 5

D- 46149 Oberhausen, www.h-p-i.de





Explanation of the symbols

 Protection class I – the appliance must have their chassis connected to electrical earth by a separate earth conductor coloured green/yellow in most countries

 Protection class II or double insulated electrical appliance is one which has been designed in such a way that it does not require a safety connection to electrical earth (ground)

 Protection class III - A Class III appliance is designed to be supplied from a separated/safety extra-low voltage (SELV) power source

 Required minimal distance between the light source and the illuminated surface (in meter) to be kept

 suitable only for low-pressure halogen lamps

 only for indoor installation

 suitable for outdoor installation (splash proof)

 Product fulfils all the valid European directives

 At the end of its lifecycle, this product must not be disposed of with your normal waste, but instead must be returned to a recycling facility for electric and electronic devices

 Infinitely dimmable via switch



Light color adjustable with switch



Memory function