

# Service card

Name

BOGOTA

Typ



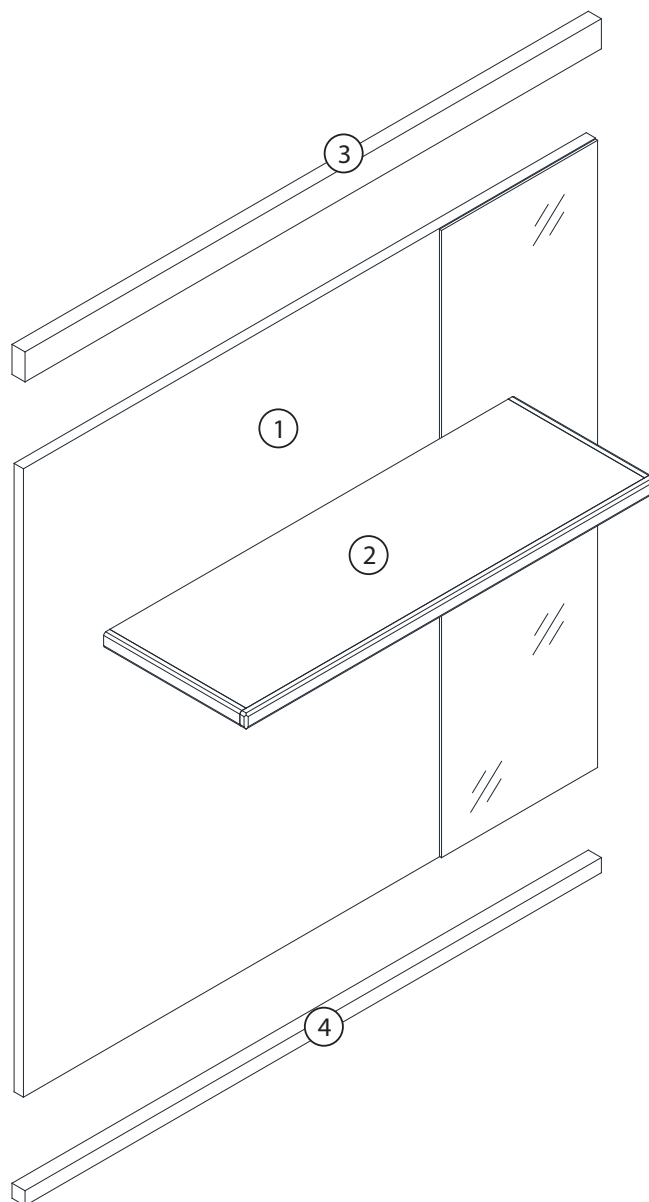
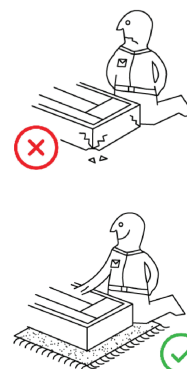
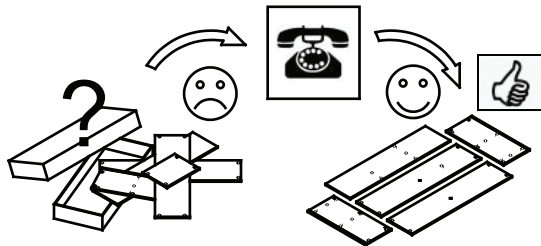
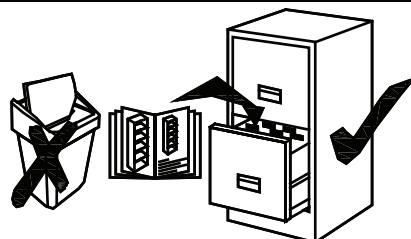

T 90 - Garderobenpaneel



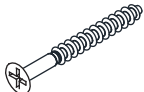

Colli 1

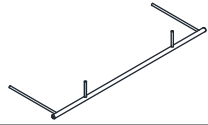
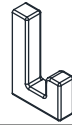
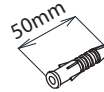
1. 1100x1045x18
2. 790x250x25
3. 1108x50x25
4. 1108x25x25

Fitings

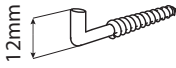
| D1  | O1  | P1  | Q1  | W1  | F1  |
|---|---|---|---|---|---|
| x5  | x4  | x1  | x3  | x2  | x2  |
| 5x70mm  | M4x30mm   |   |   | L=50mm  | 25x25mm   |
|  |  |  |  |  |  |

| Z1  | L1  | J1  |
|---|---|---|
| x2  | x6  | x2  |
|   | M4x25mm   | 35mm  |
|  |  |  |

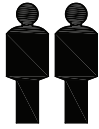
Modellname: **BOGOTA****MONTAGEANLEITUNG**  
**T 90 - Garderobenpaneel**

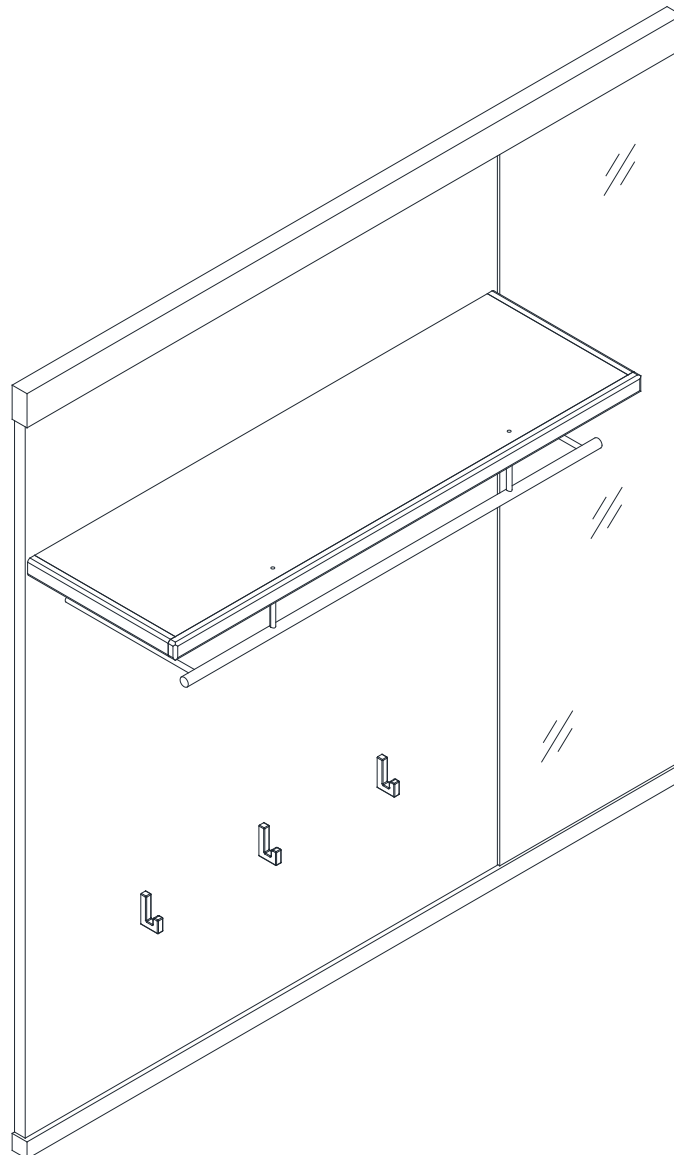
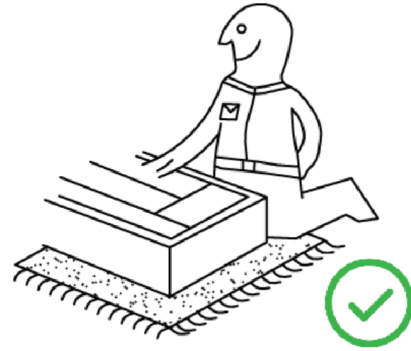
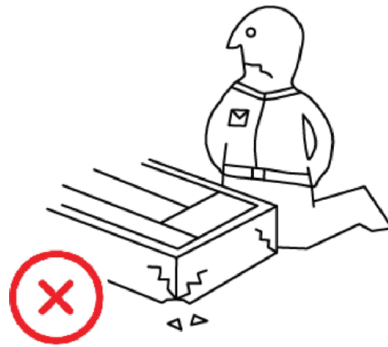
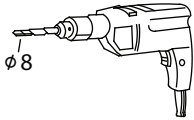
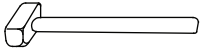
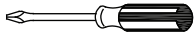
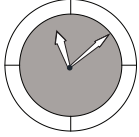

2 Persons

30min



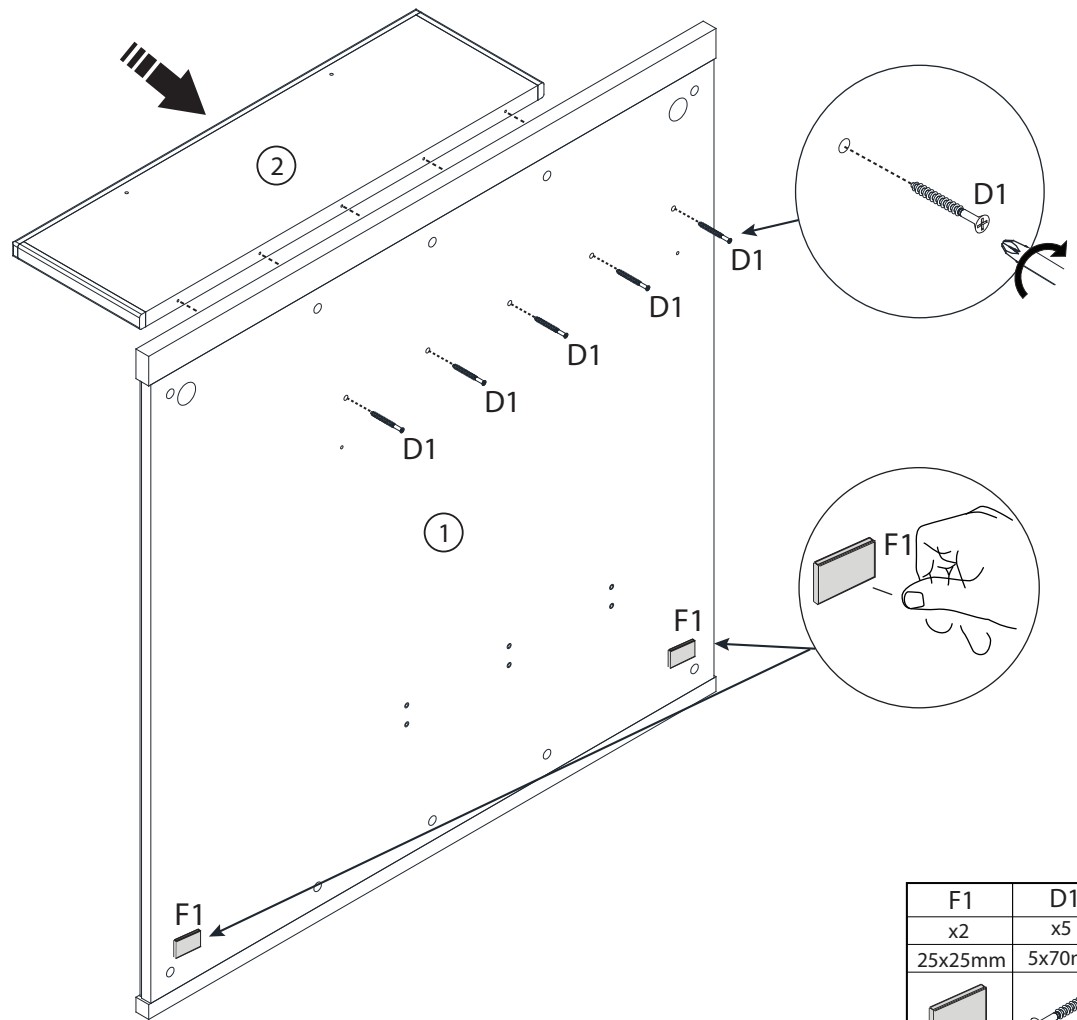

1.

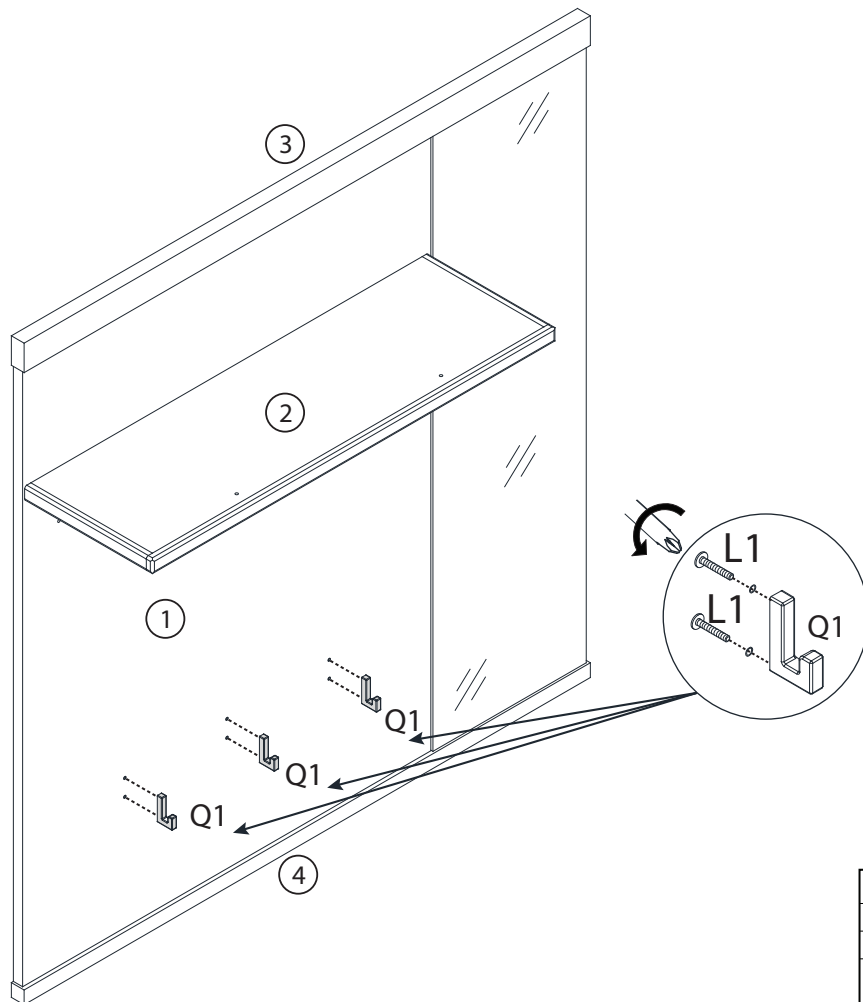

| F1  | D1  |
|---|---|
| x2  | x5  |
| 25x25mm   | 5x70mm  |
|  |  |

2.



| Q1  | L1  |
|---|---|
| x3  | x6  |
|   | M4x25mm   |
|  |  |

3.

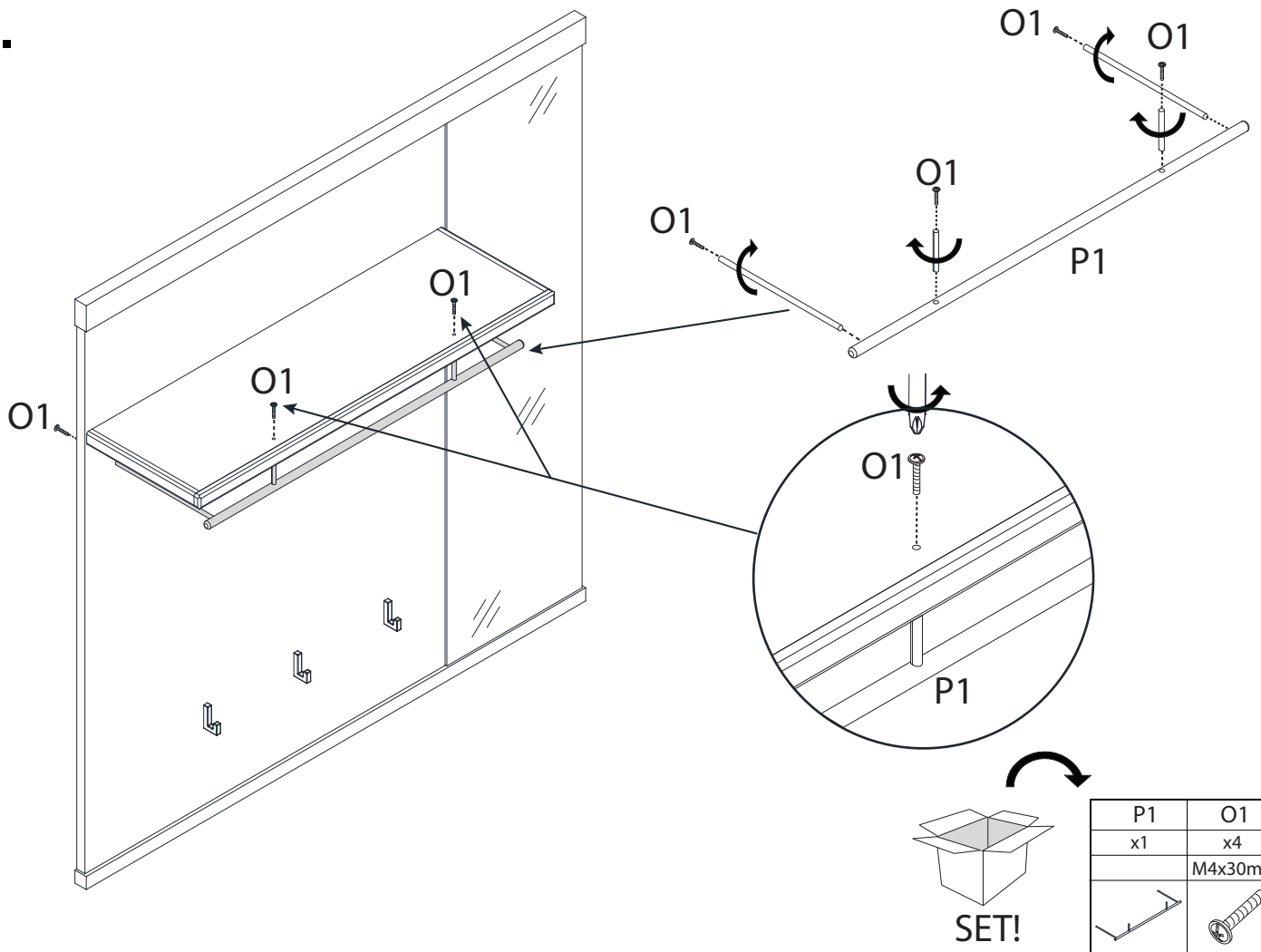

4.

