

Ⓓ Aufbauanleitung

Ⓕ Notice de montage

Ⓖ Montagehandleiding

Ⓒ Montážní návod

Ⓗ Szerelési útmutató

Ⓓ Montaj talimatları

Ⓖ Assembly instruction

Ⓙ Istruzione di montaggio

Ⓟ Instrukcja montażu

Ⓚ Navod na montaž

Ⓡ Instrucțiuni de montaj

Ⓡ Инструкция по монтажу

37-0001-32-09A

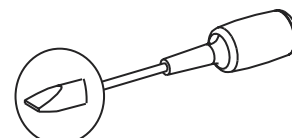
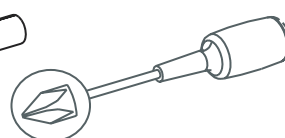
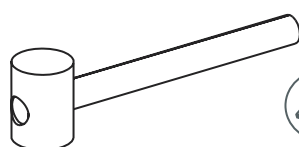
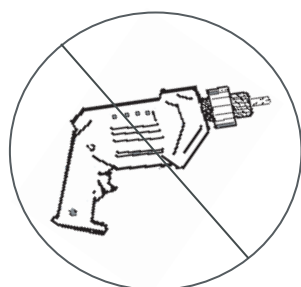
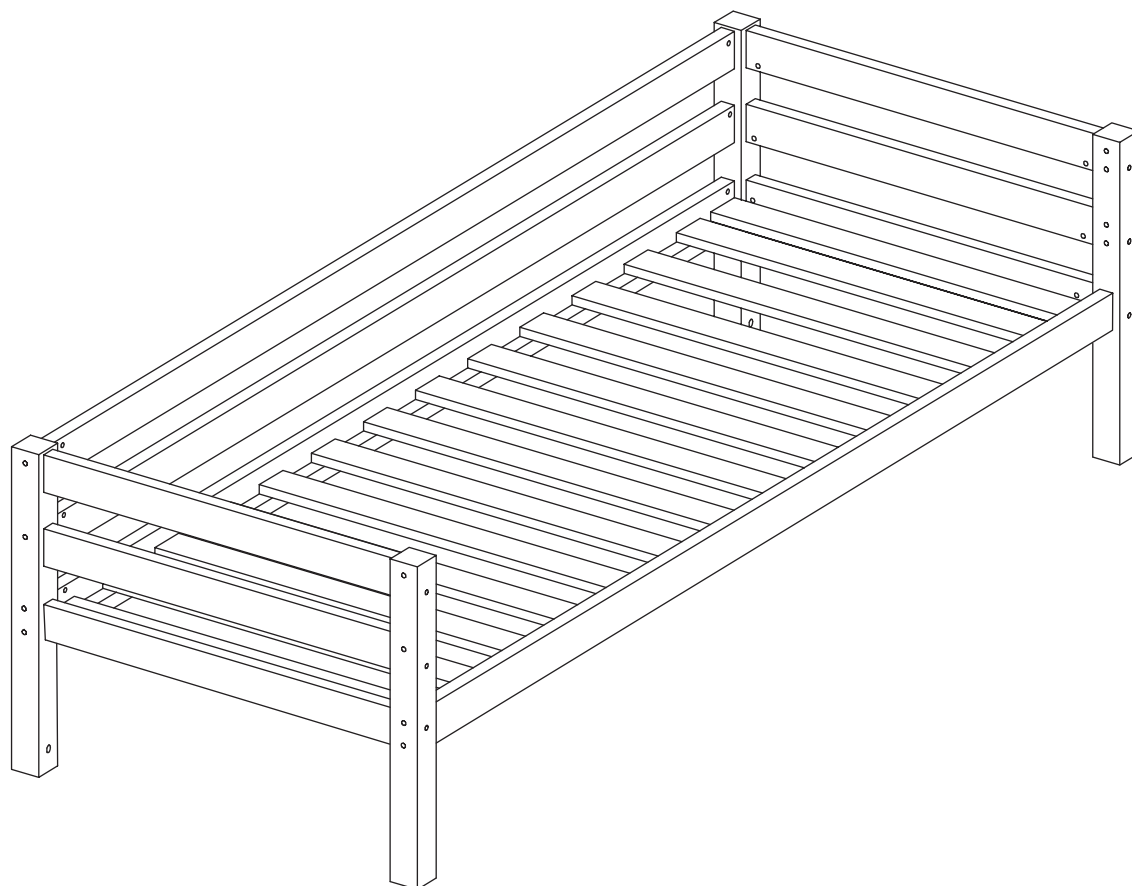

DIN EN 747-1:2015
DIN EN 747-2:2015

Service • Assistenza • Dienstverlening • Serwis Servis • Szerviz • Сервисная служба

Name • Nom • Nome • Naam • Nazwa • Jméno • Názov
Név • Denumire • Isim • Название

Nr. Nr. • No. • N° • Č • Sz • Номер

Typ • Тип • Type • Tip • Tipus • Druh • Тиро • Тип

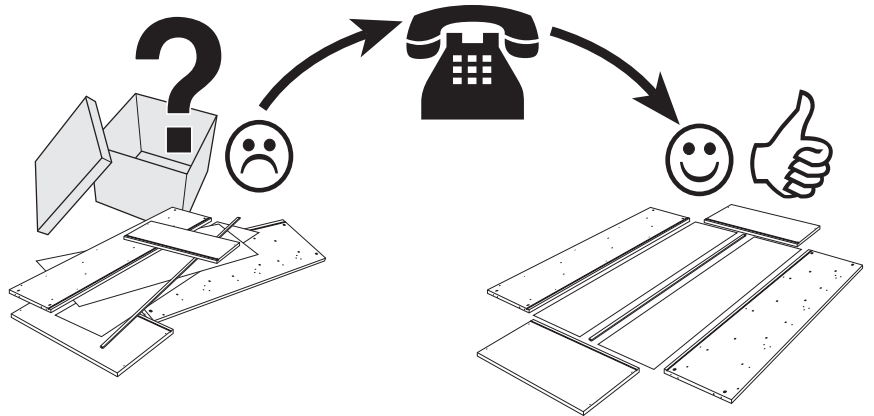
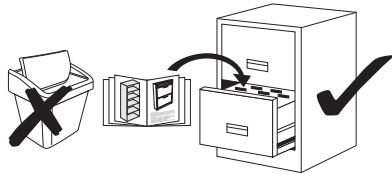

Detail specification

A.i. Nr.	Article Nr.	pcs
①	013001-32	x2
②	013002-32	x2
③	013003-32	x2
④	013004-32	x2
⑤	013005-32	x2
⑥	013006-32	x4
⑩	108820-00	x16

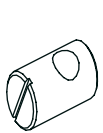
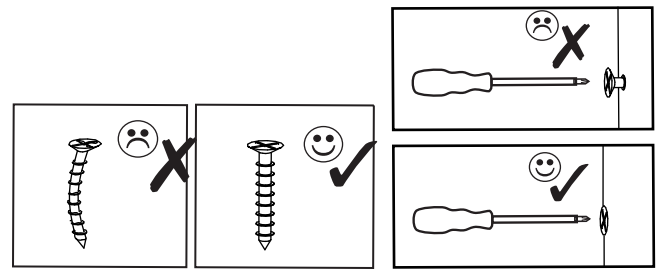
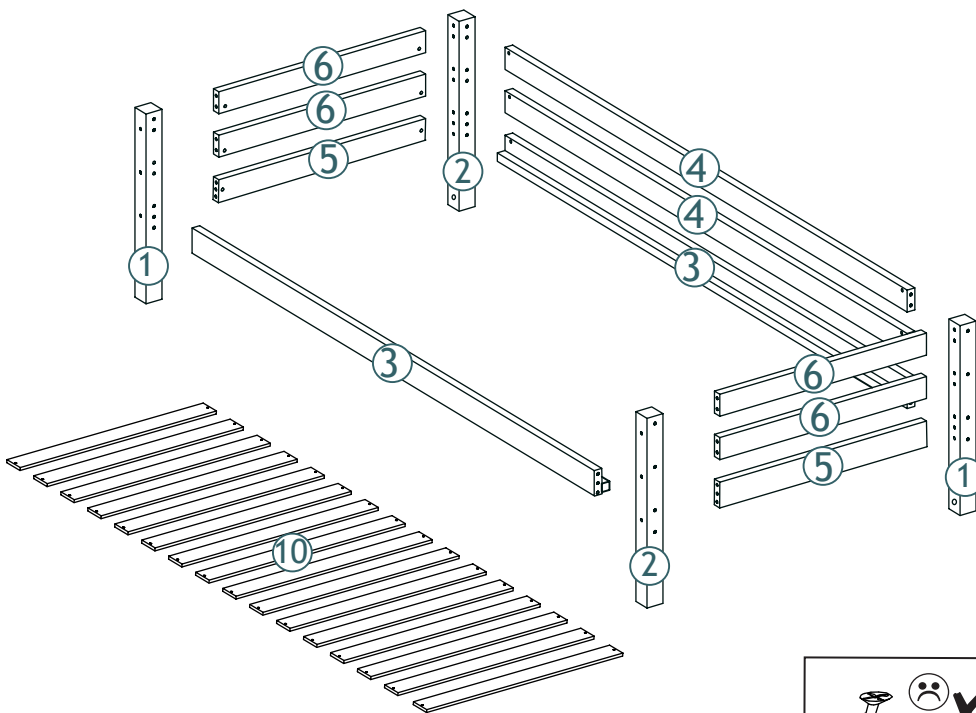

a

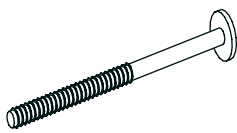

b

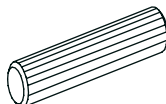

c

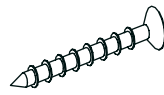

d



e

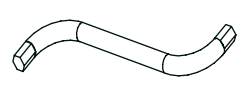

f

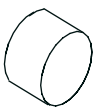

g

Fitting specification

A.i. Nr.	Article Nr.	Dimensions	pcs
a	1-000011-07	10x18	x24
b	1-000010-07	M6x100	x24
c	1-000013-00	8x40	x24
d	1-000012-07	3x30	x32
e	1-000014-57	6x8	x12
f	1-000015-07	Z4	x1
g	1-000016-57	16x10	x4

Make sure that there are no loose and leave screws!
Stellen Sie sicher, dass keine losen Schrauben und verlassen!
Zorg ervoor dat er geen losse en laat schroeven!
Assurez-vous qu'il n'y a pas lâches et laissent vis!

1-000001=

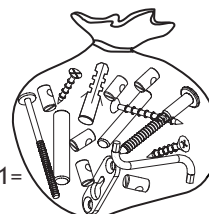

Ⓛ Aufbauanleitung

Ⓛ Notice de montage

Ⓛ Montagehandleiding

Ⓛ Montážní návod

Ⓛ Szerelési útmutató

Ⓛ Montaj talimatları

Ⓛ Assembly instruction

Ⓛ Istruzione di montaggio

Ⓛ Instrukcja montażu

Ⓛ Navod na montaž

Ⓛ Instrucțiuni de montaj

Ⓛ Инструкция по монтажу

37-0002-32-200

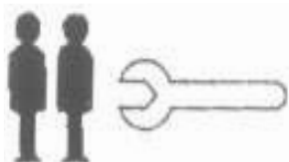
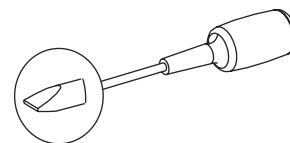
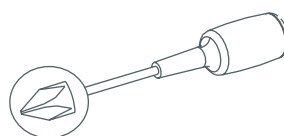
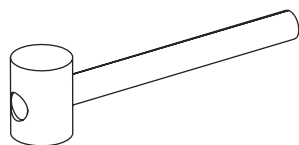
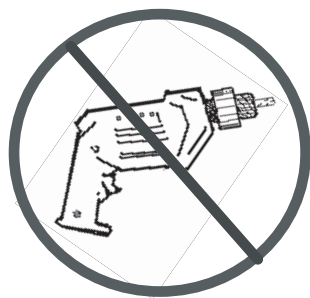
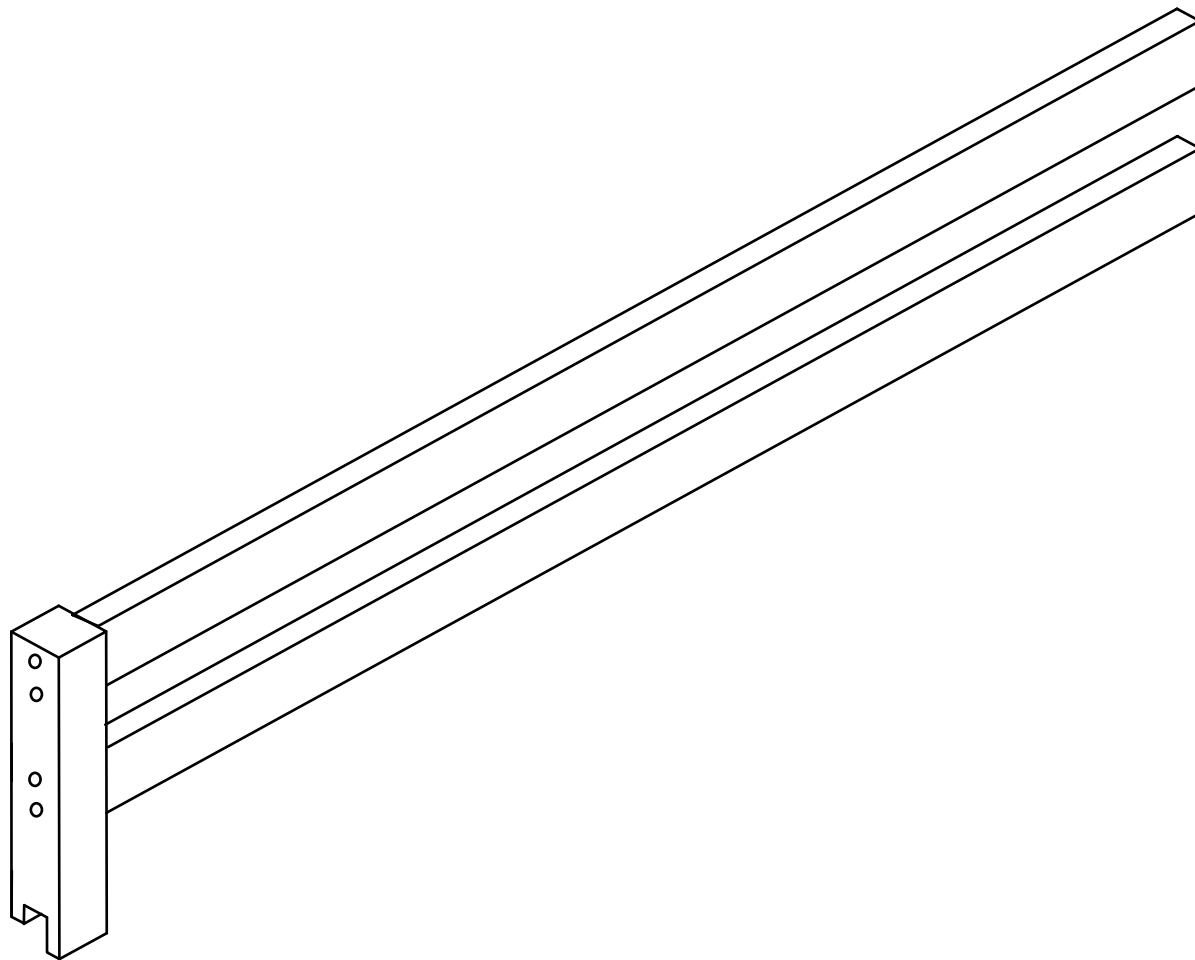

DIN EN 747-1:2015
DIN EN 747-2:2015



Service • Assistenza • Dienstverlening • Serwis Servis • Szerviz • Сервисная служба

Name • Nom • Nome • Naam • Nazwa • Jméno • Názov
Név • Denumire • Isim • Название

Nr. • No. • N° • Č • Sz • Номер

Typ • Type • Tip • Tipus • Druh • Тип • Тип

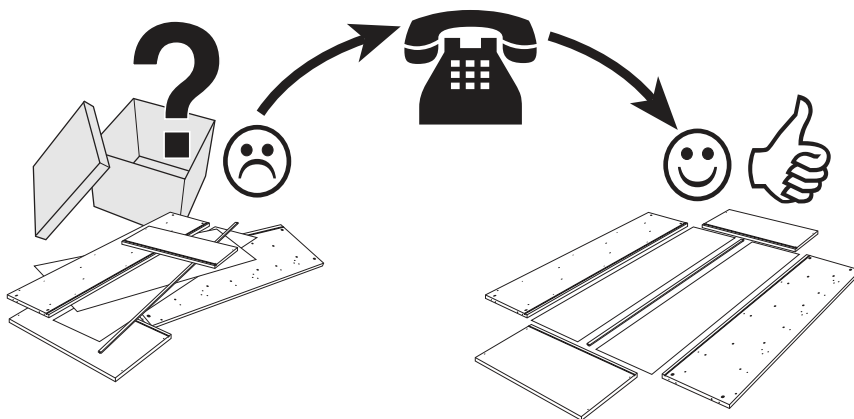
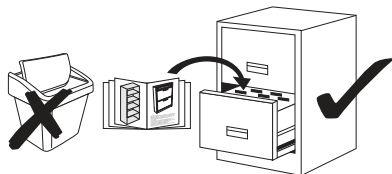

Detail specification

A.i. Nr.	Article Nr.	pcs
7	013007-32	x1
8	013008-32	x2

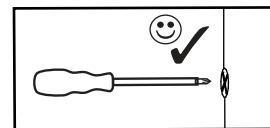
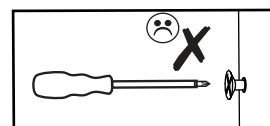
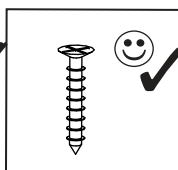
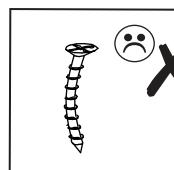
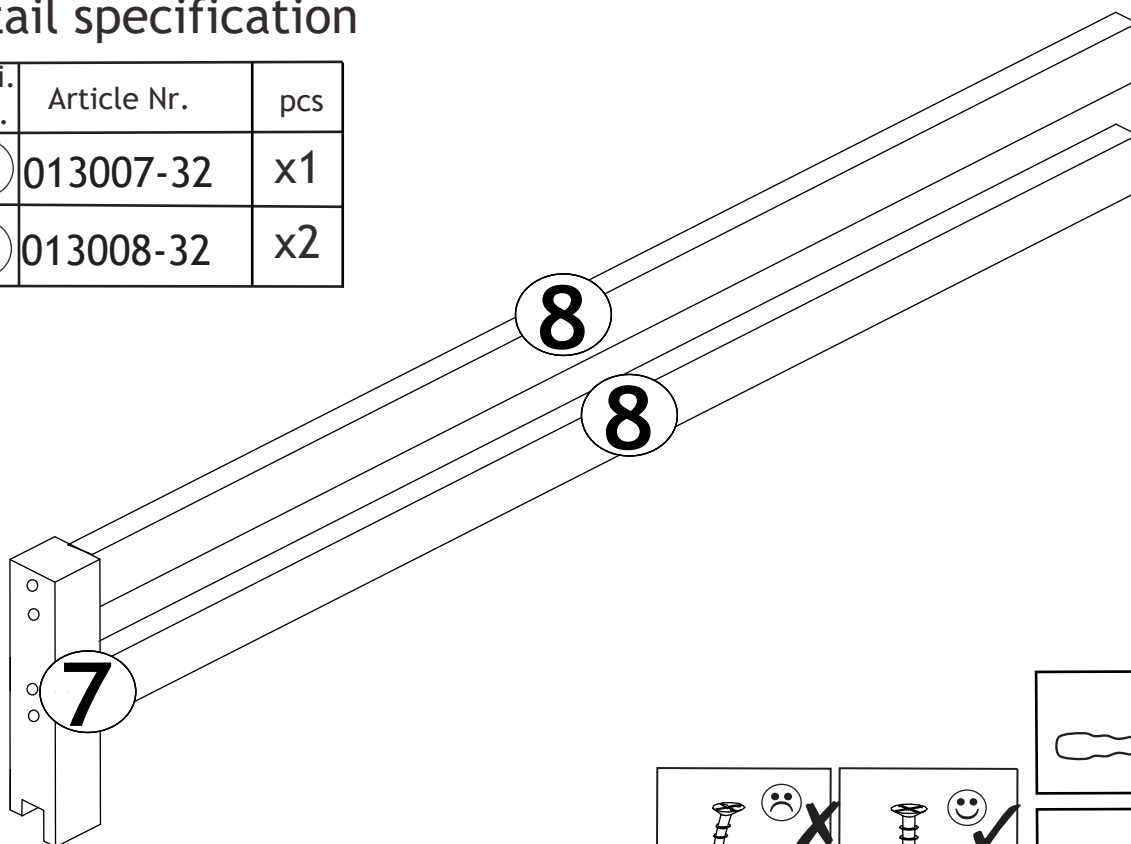

h



i

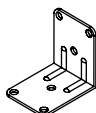

j



c

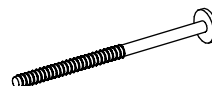

b



a



e



g

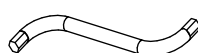

f

Fitting specification

A.i. Nr.	Article Nr.	Dimensions	pcs
h	1-000020-07	3,5x25	x3
i	1-000019-07	3,5x15	x4
j	1-000018-07	48x40x2,5	x1
c	1-000013-00	8x40	x4
b	1-000010-07	M6x100	x4
a	1-000011-07	M6x10/18	x4
e	1-000014-57	6x8	x2
g	1-000017-07	45x45x2	x1
f	1-000015-07	Z4	x1

1-000001=

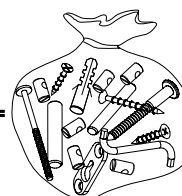

37-0001+37-0002

1.

2.

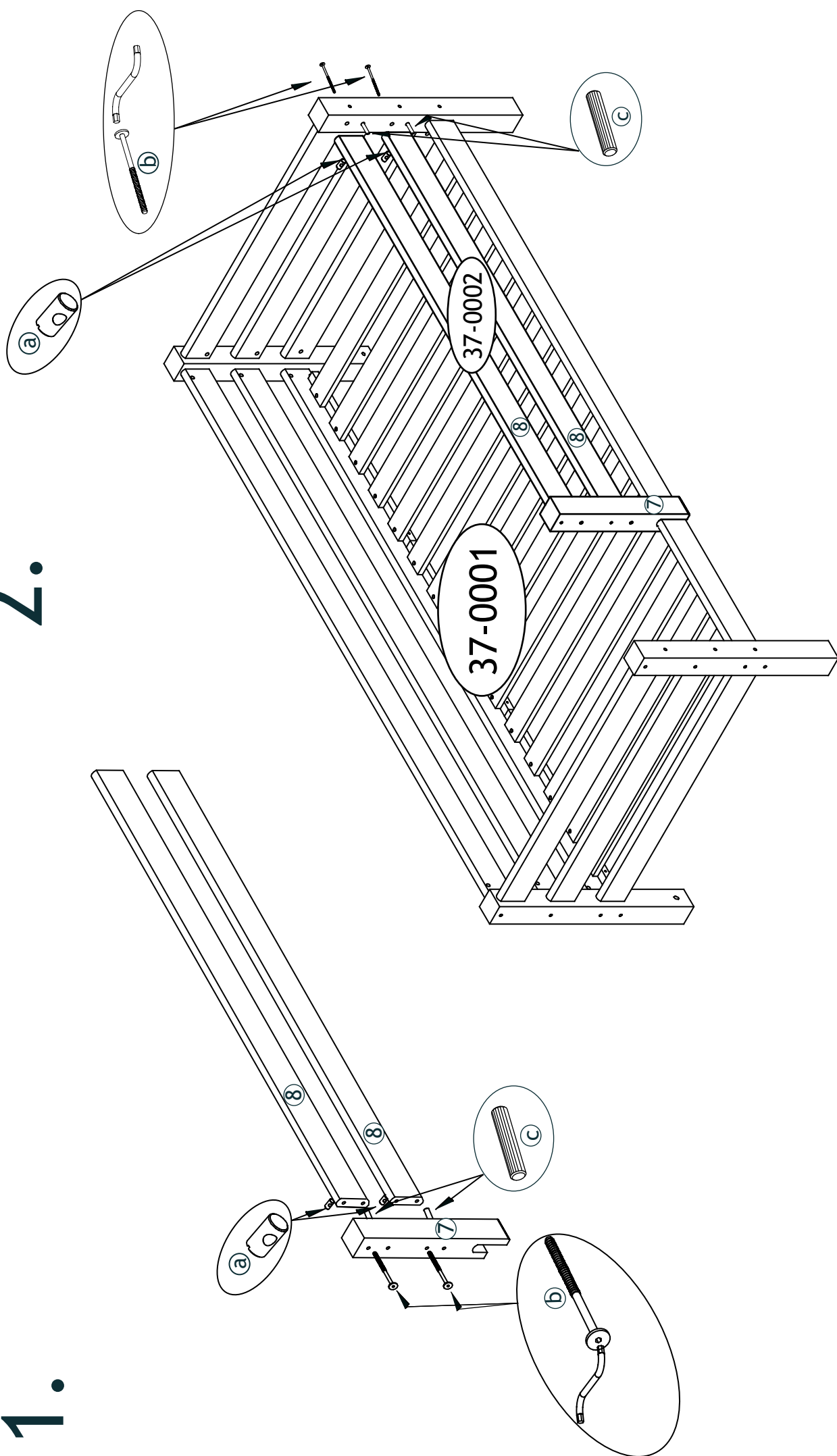

3.

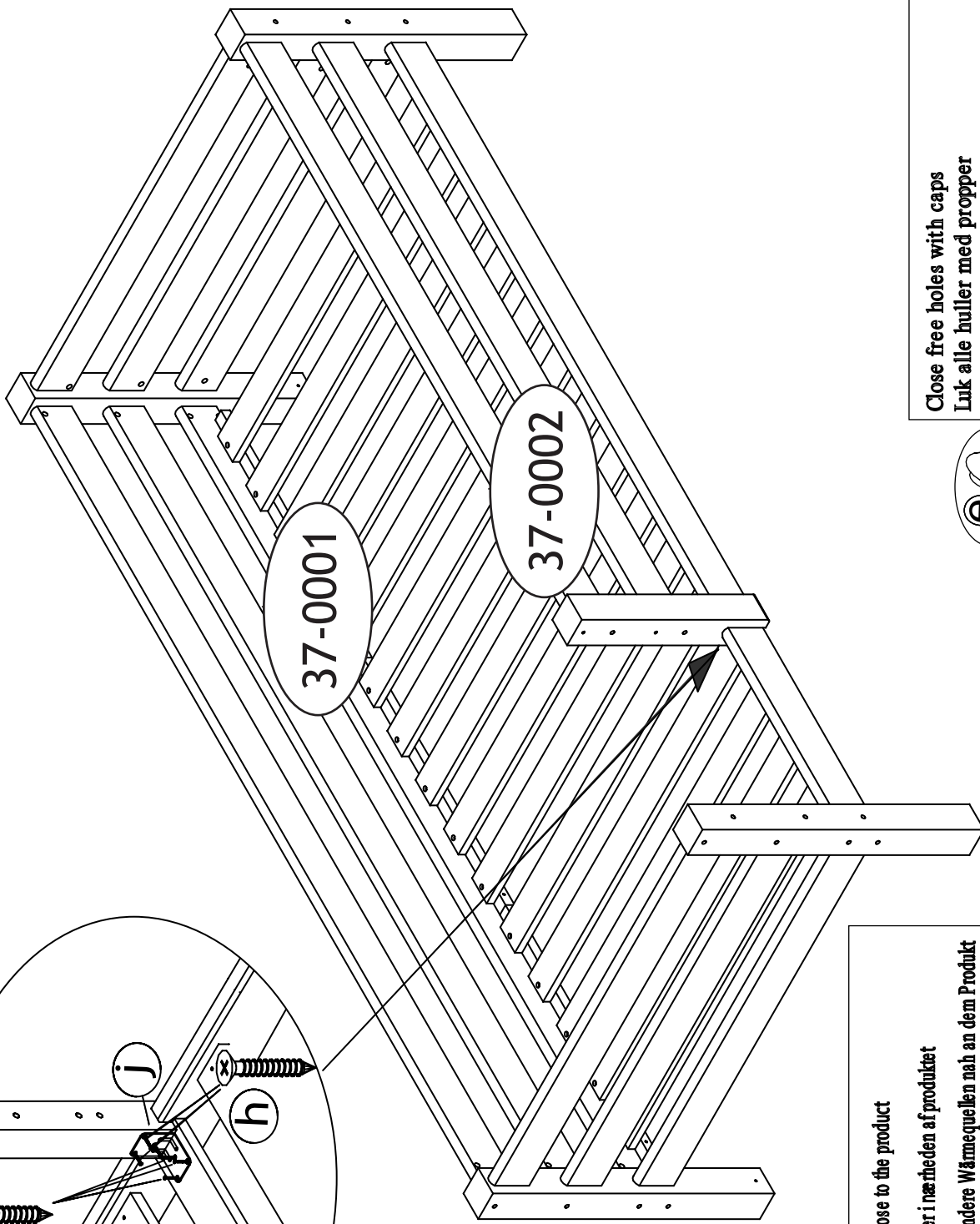
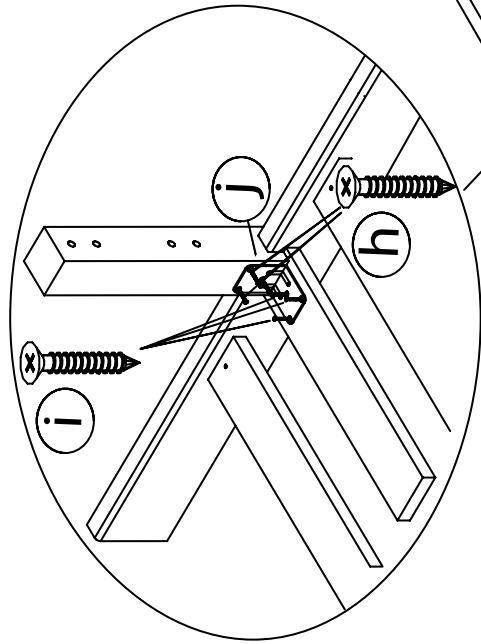

- (UK)** Be aware of the risk of open fire and other heating sources close to the product
- (DK)** Vær opmærksom på risikoen for åben ild og andre varmekilder i nærheden af produktet
- (DE)** Berücksichtigen Sie die Gefahr des geöffneten Feuers und andere Wärmequellen nah an dem Produkt
- (FR)** Ne pas placer le produit à proximité du feu ou du chauffage puissant

Close free holes with caps
Luk alle huller med propper
Schliessen Sie die offenen Löcher mit den Deckkappen
Fermez les trous découverts avec les chapes



37-0017+37-0002

1.

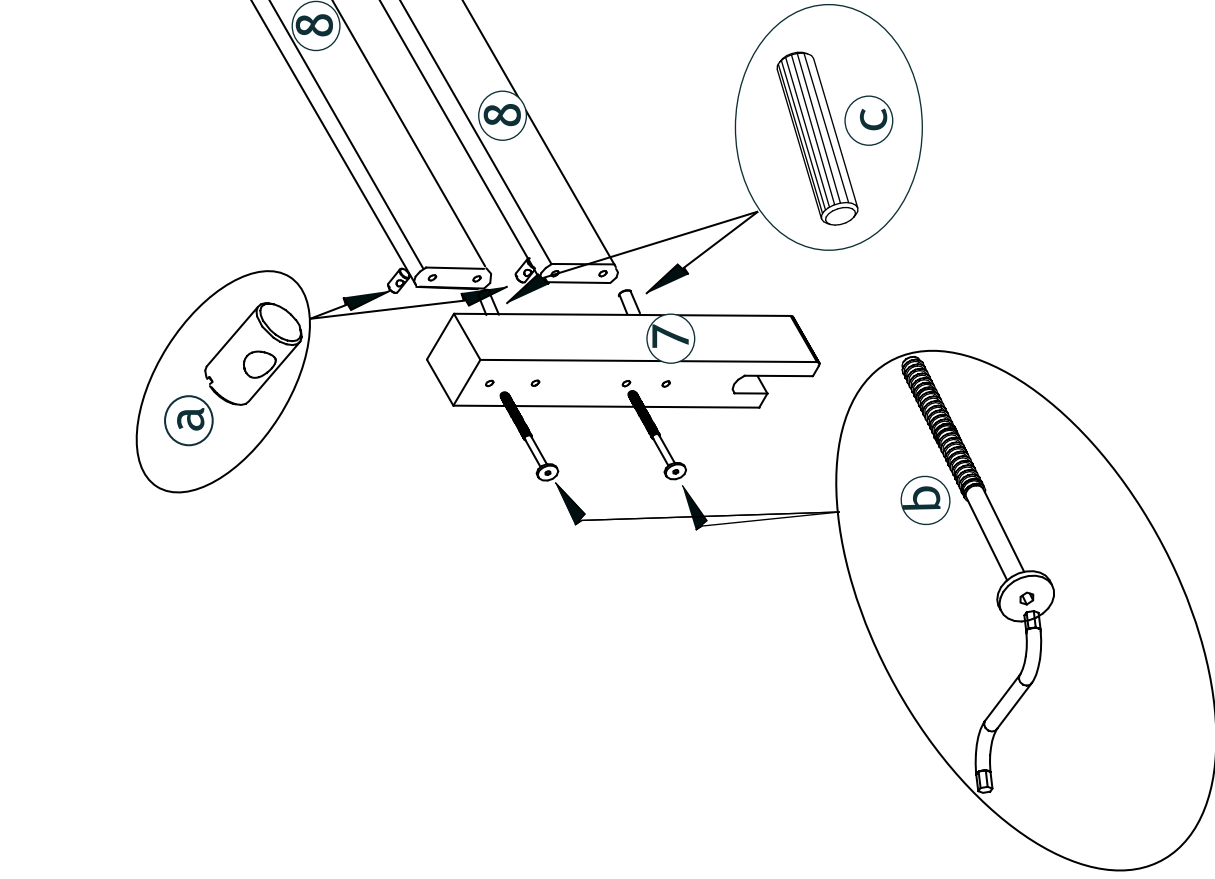

2.

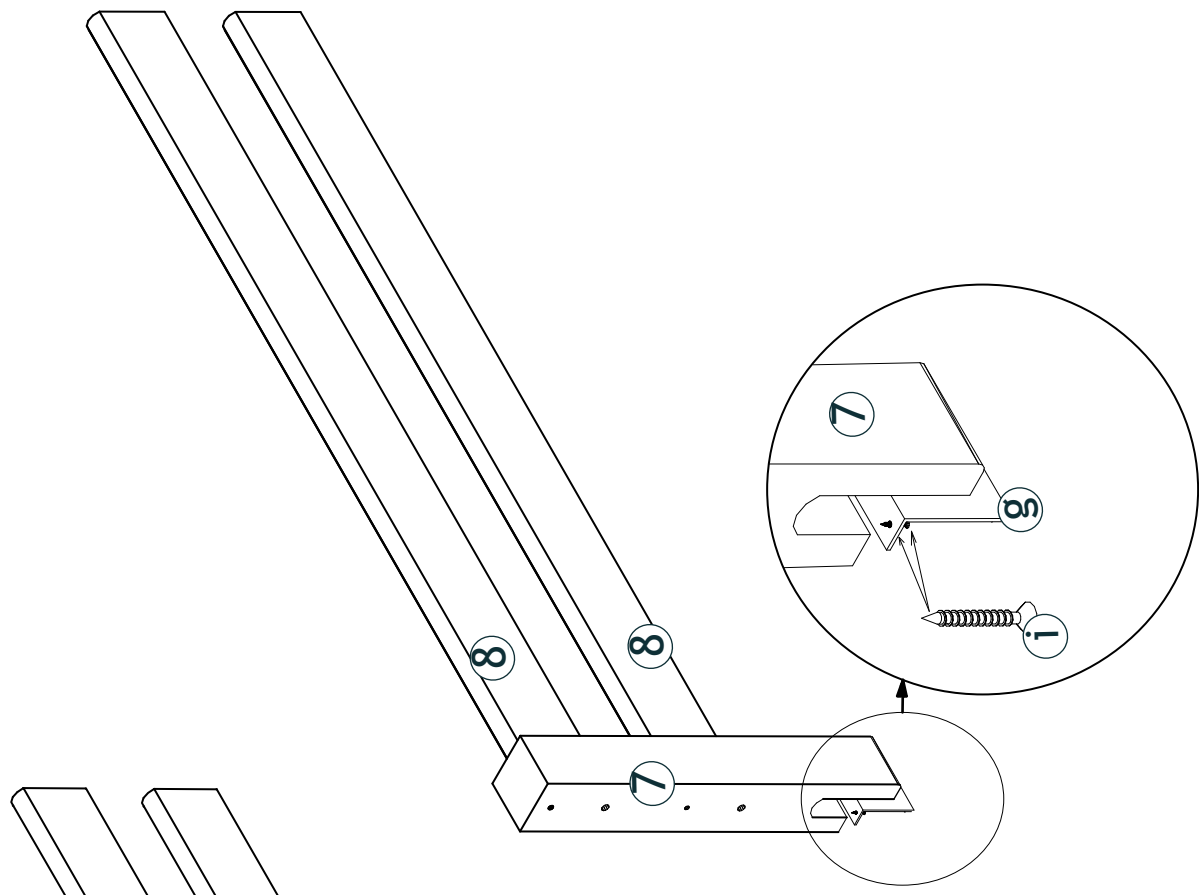

3.

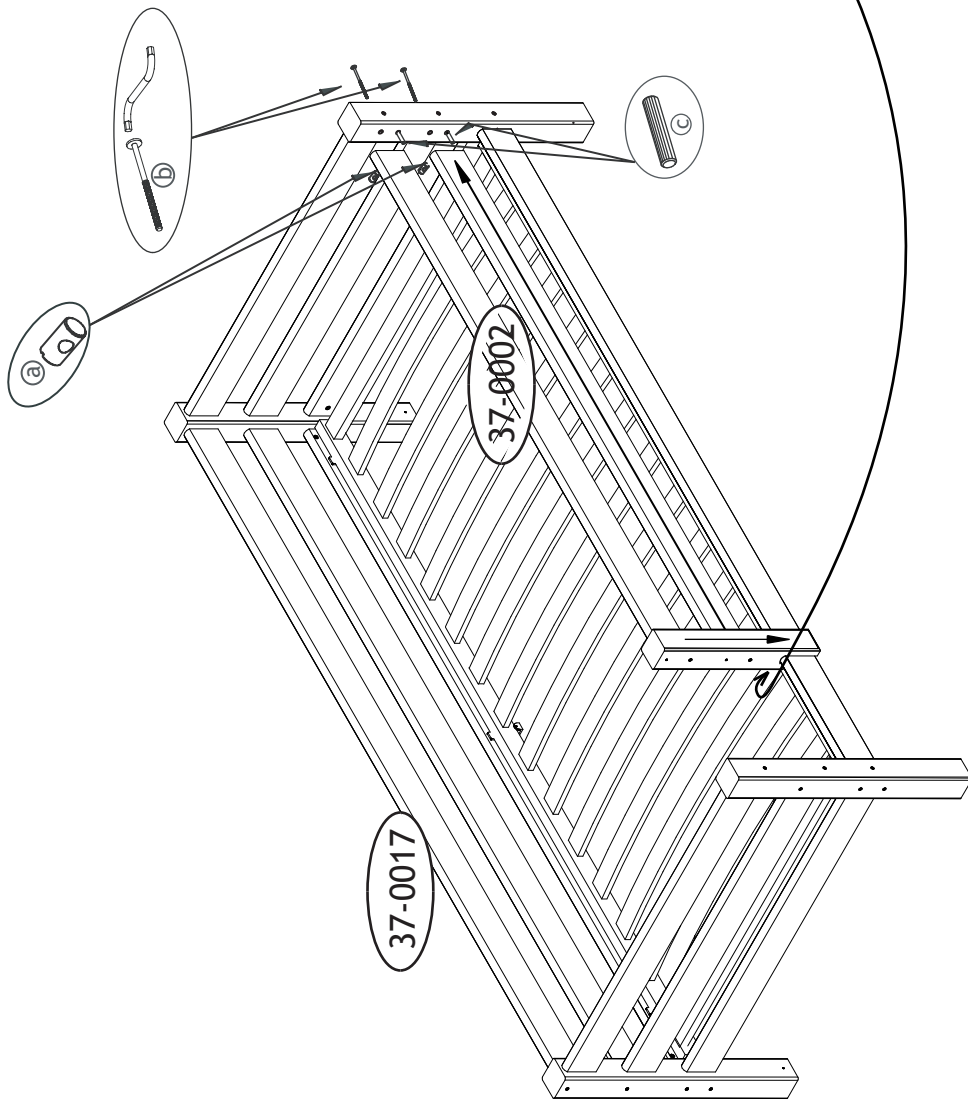

4.

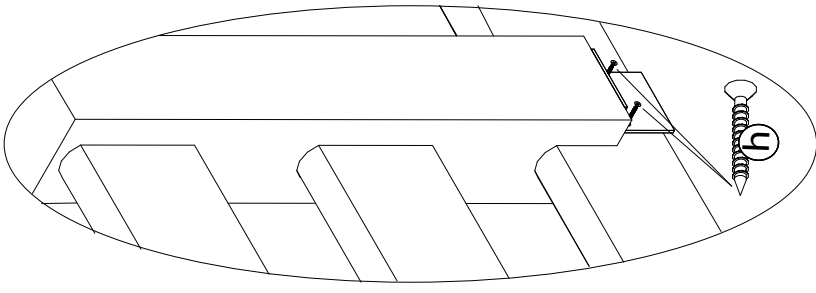

- (UK)** - Be aware of the risk of open fire and other heating sources close to the product
- (DK)** - Vær opmærksom på risikoen for åben ild og andre varmekilder i nærheden af produktet
- (DE)** - Berücksichtigen Sie die Gefahr des geöffneten Feuers und andere Wärmequellen nah an dem Produkt
- (FR)** - Ne pas placer le produit à proximité du feu ou du chauffage puissant

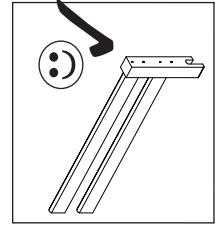
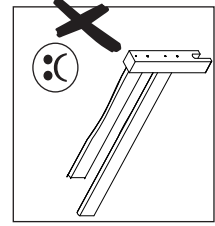

Close free holes with caps
 Luk alle huller med propper
 Schliessen Sie die offenen Löcher mit den Deckkappen
 Fermez les trous découverts avec les chapes



Ⓓ Aufbauanleitung

Ⓕ Notice de montage

Ⓖ Montagehandleiding

Ⓒ Montážní návod

Ⓗ Szerelési útmutató

Ⓓ Montaj talimatları

Ⓖ Assembly instruction

Ⓙ Istruzione di montaggio

Ⓟ Instrukcja montażu

Ⓚ Navod na montaž

Ⓡ Instrucțiuni de montaj

Ⓡ Инструкция по монтажу

37-0001-32-09A

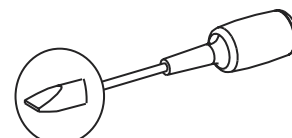
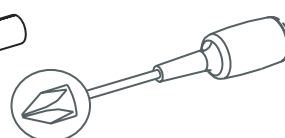
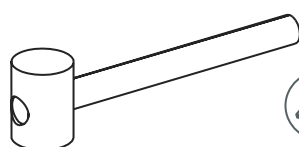
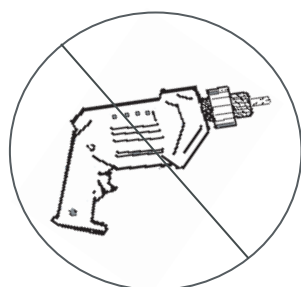
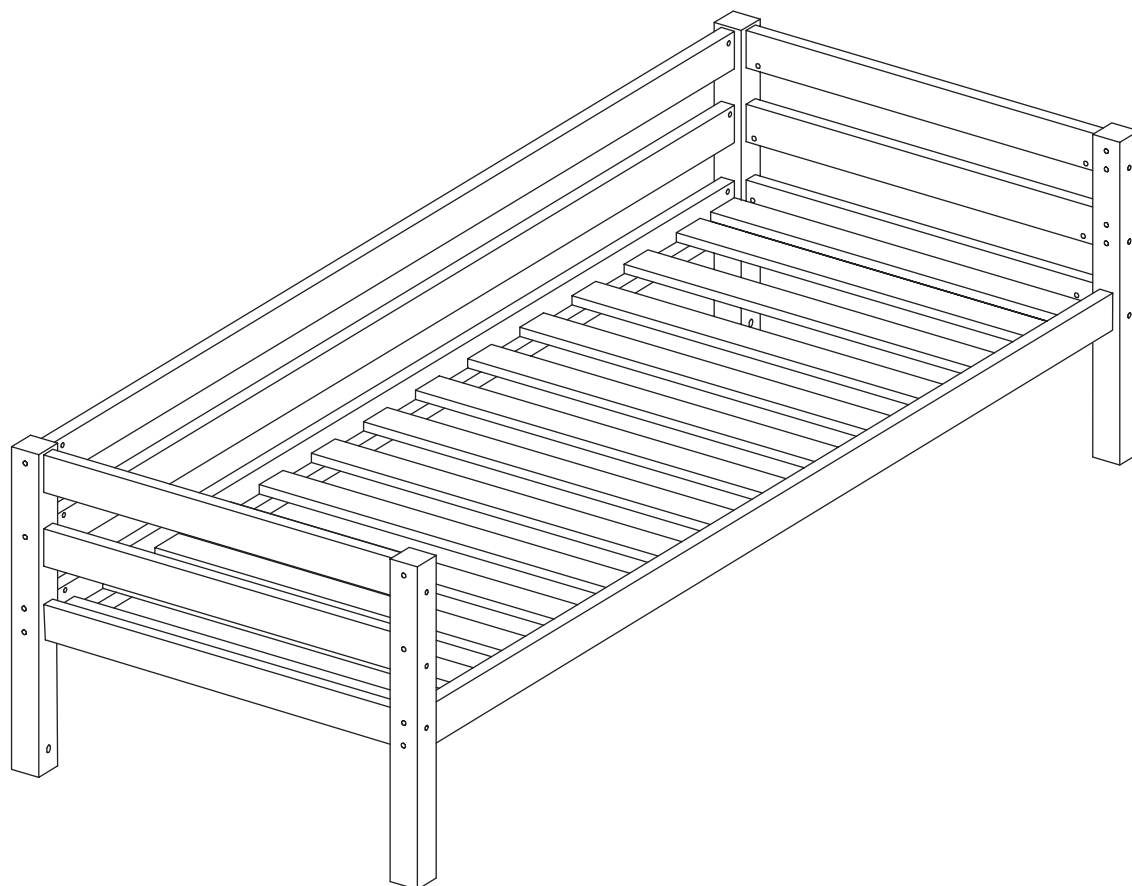

DIN EN 747-1:2015
DIN EN 747-2:2015

Service • Assistenza • Dienstverlening • Serwis Servis • Szerviz • Сервисная служба

Name • Nom • Nome • Naam • Nazwa • Jméno • Názov
Név • Denumire • Isim • Название

Nr. Nr. • No. • N° • Č • Sz • Номер

Typ • Тип • Type • Tip • Tipus • Druh • Тиро • Тип

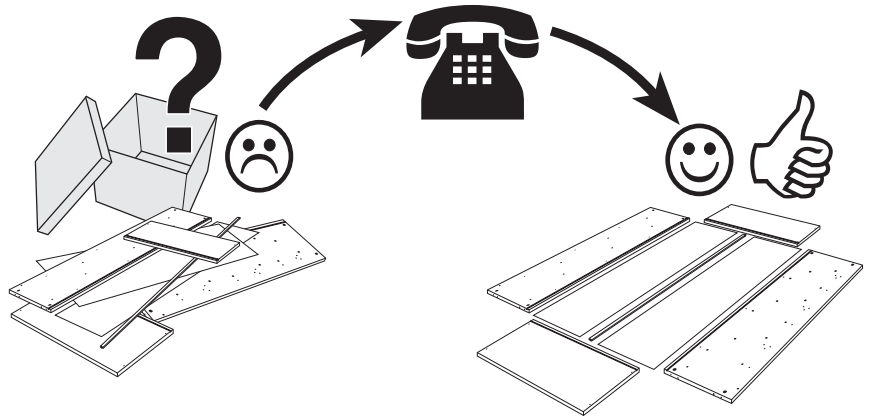
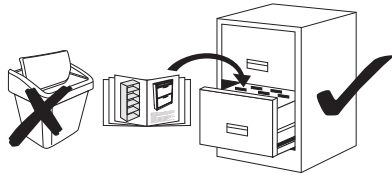

Detail specification

A.i. Nr.	Article Nr.	pcs
①	013001-32	x2
②	013002-32	x2
③	013003-32	x2
④	013004-32	x2
⑤	013005-32	x2
⑥	013006-32	x4
⑩	108820-00	x16

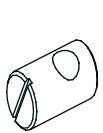
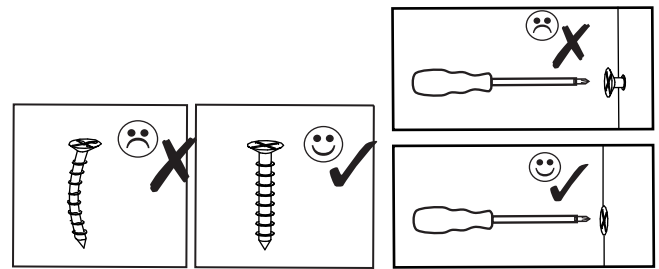
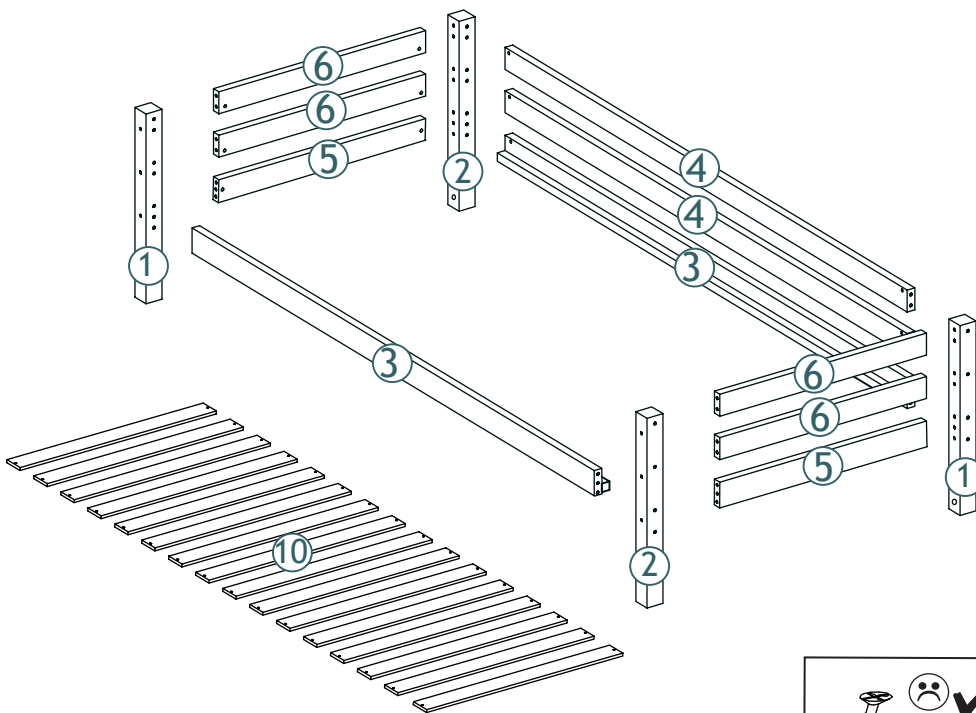

a

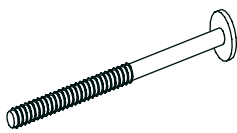

b

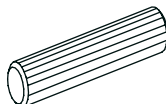

c

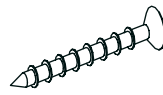

d



e

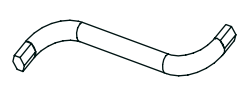

f

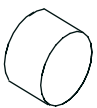

g

Fitting specification

A.i. Nr.	Article Nr.	Dimensions	pcs
a	1-000011-07	10x18	x24
b	1-000010-07	M6x100	x24
c	1-000013-00	8x40	x24
d	1-000012-07	3x30	x32
e	1-000014-57	6x8	x12
f	1-000015-07	Z4	x1
g	1-000016-57	16x10	x4

Make sure that there are no loose and leave screws!
Stellen Sie sicher, dass keine losen Schrauben und verlassen!
Zorg ervoor dat er geen losse en laat schroeven!
Assurez-vous qu'il n'y a pas lâches et laissent vis!

1-000001=

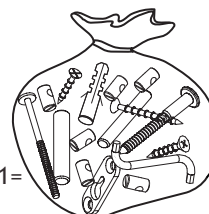

Ⓓ Aufbauanleitung

Ⓕ Notice de montage

Ⓖ Montagehandleiding

Ⓒ Montážní návod

Ⓗ Szerelési útmutató

Ⓓ Montaj talimatları

Ⓖ Assembly instruction

Ⓙ Istruzioni di montaggio

Ⓟ Instrukcja montażu

Ⓚ Navod na montaž

Ⓡ Instrucțiuni de montaj

Ⓡ Инструкция по монтажу

37-0041-32-000

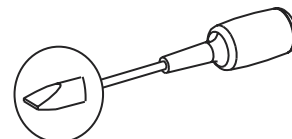
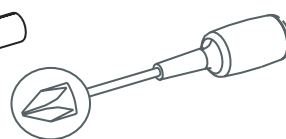
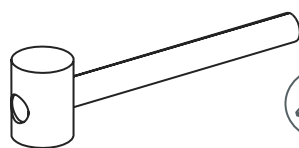
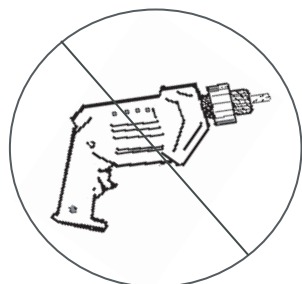

Service • Assistenza • Dienstverlening • Serwis Servis • Szerviz • Сервисная служба

Name • Nom • Nome • Naam • Nazwa • Jméno • Názov
Név • Denumire • Isim • Название

Nr. Nr. • No. • N° • Č • Sz • Номер

Typ • Тип • Type • Tip • Tipus • Druh • Тиро • Тип

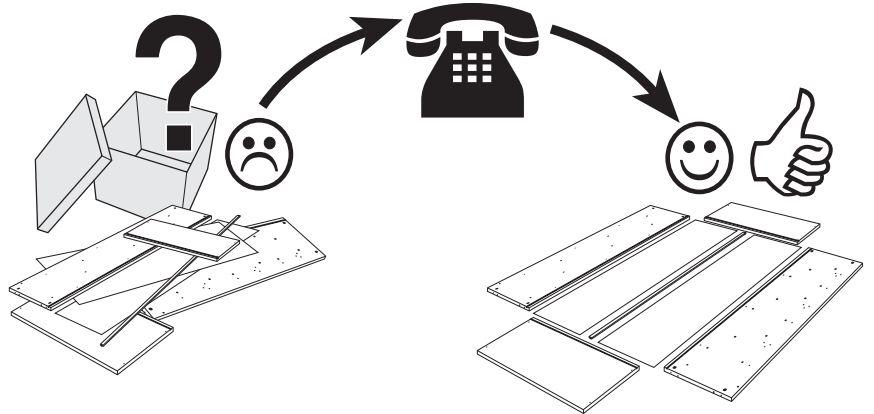
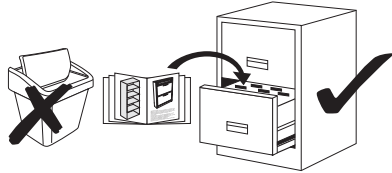

65	013133-32	x2
66	013134-32	x2

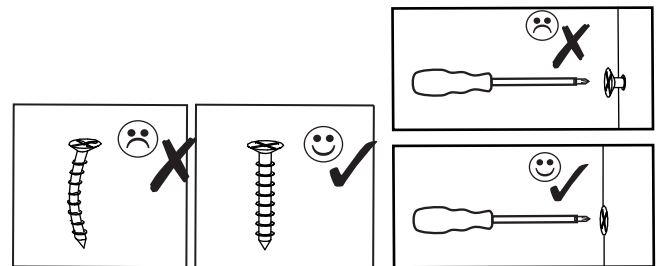

Fitting specification

A.i. Nr.	Article Nr.	Dimentions	pcs
f	1-000015-07	Z4	x1
l	1-000021-07	M10x15/28	x8
m	1-000022-07	M10x15/28	x4
n	1-000023-07	M10x115	x4
k	1-000024-07	M10x12	x8
g	1-000016-57	16x10	x8
o	1-000166-07	10x80	x4
p	1-000041-07	M6x55	x4
h	1-000027-07	8x15	x4
q	1-000220-07	77x15x21	x2
v	1-000222-07	3x42	x2
z	1-000221-07	3x15	x4
u	1-000223-57	6x29	x2

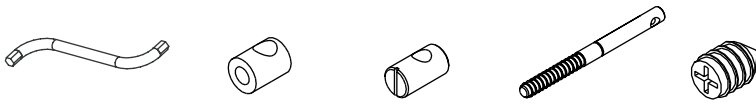

f l m n k



g p h o

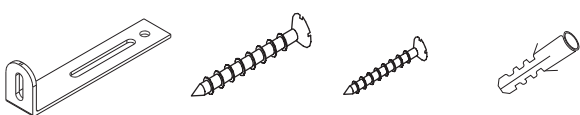

q v z u

1-000001=

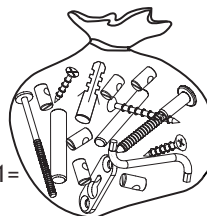

0
10
20
30
40
50
60
70
80
90
100
110
120
130
140
150
160
170
18

1.

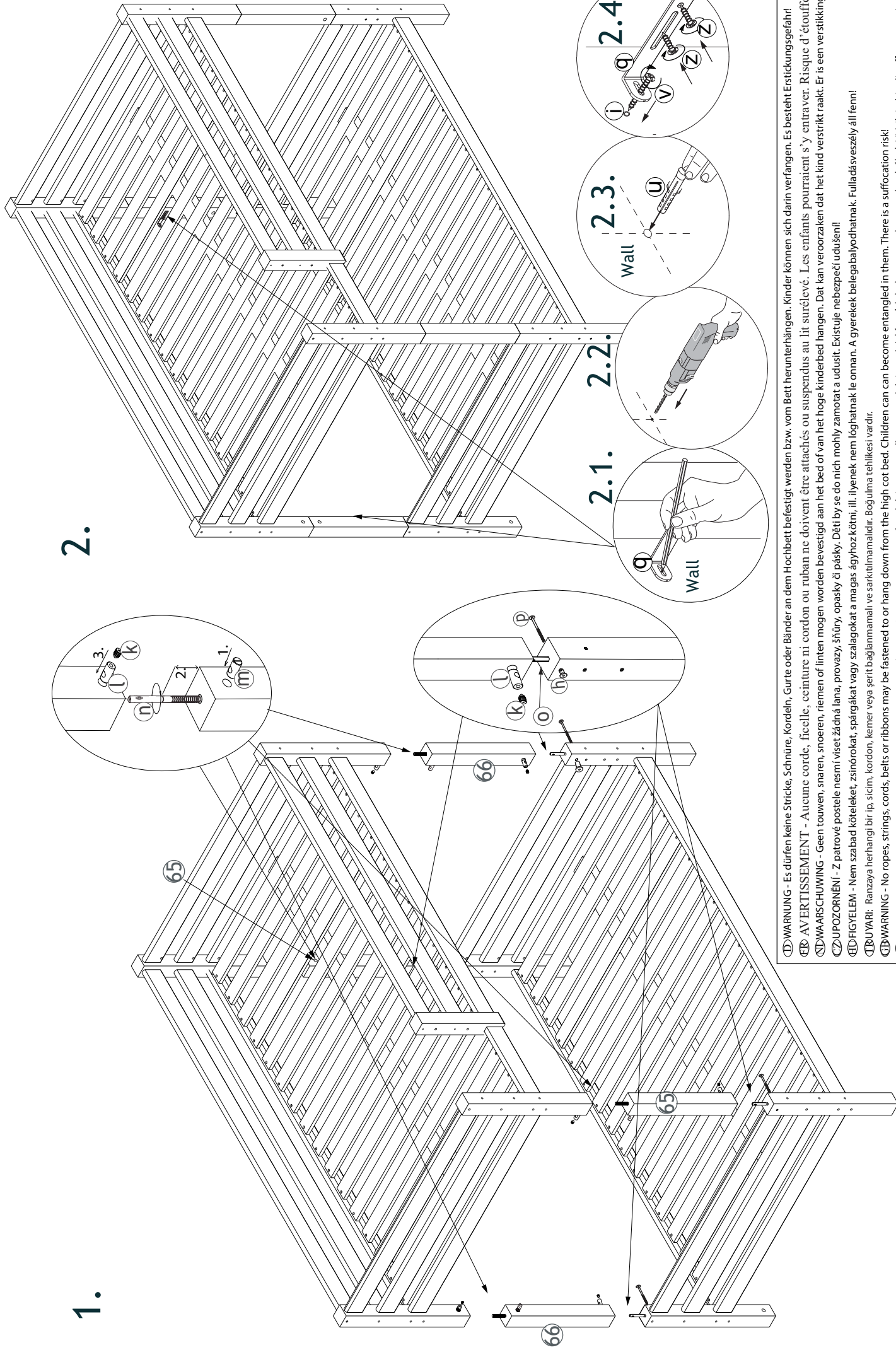
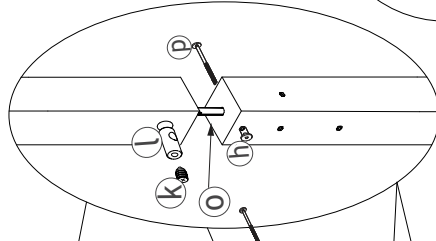
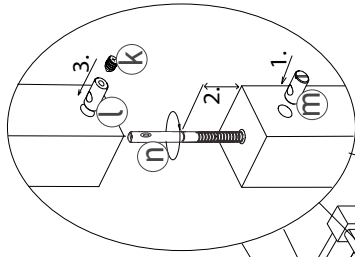

2.

2.1.

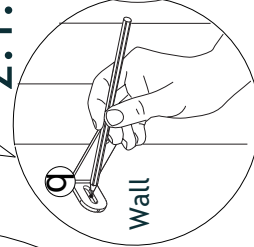

2.2.

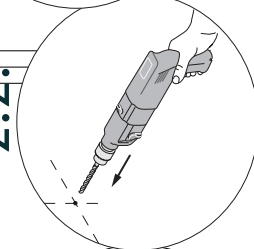

2.3.

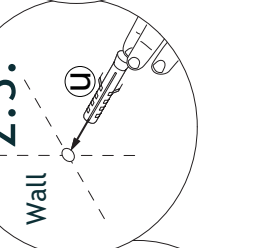

2.4.

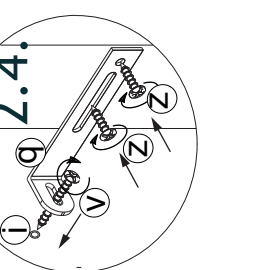

Close free holes with caps
 Luk alle huller med propper
 Schliessen Sie die offenen Löcher mit den Deckkappen
 Fermez les trous découverts avec les chapes

- ⚠ **WARUNG** - Es dürfen keine Stricke, Schnüre, Kordeln, Gurte oder Bänder an dem Hochbett befestigt werden bzw. vom Bett herunterhängen. Kinder können sich darin verfangen. Es besteht Erstickengefahr!
- ⚠ **AVERTISSEMENT** - Aucune corde, ficelle, ceinture ni cordon ou ruban ne doivent être attachés ou suspendus au lit surélevé. Les enfants pourraient s'y entraver. Risque d'étouffement!
- ⚠ **WAARSCHUWING** - Geen touwen, snaren, snoeren, riemen of linten mogen worden bevestigd aan het bed of van het hoge kinderbed hangen. Dat kan veroorzaken dat het kind verstrikt raakt. Er is een verstikkingsrisico!
- ⚠ **OPPOZORNENI** - Z. patrové postele nesmí viset žádná lana, provazy, šňůry, opasky či pásky. Děti by se do nich mohly zamotat a udušit. Existuje nebezpečí udušení!
- ⚠ **FIGYELEM** - Nem szabad köteleket, zsinórokat, spárgákat vagy szalagokat a magas ágyhoz kötni, ill. ilyenek nem lóghatnak le onnan. A gyerekek belegabalyodhatnak. Fulladásveszély áll fenn!
- ⚠ **UYARI** - Ranzaya herhangı bir ip, sicim, kordon, kemer veya şerit bağlanmamalı ve saiktilmamalıdır. Boğulma tehlikesi vardır.
- ⚠ **ATTENZIONE** - Al lettino non devono essere attaccati o appesi funi, corde, cavi, cravatte, cordoncini (cravatte gibt es gar nicht) perché i bambini vi possono rimanere impigliati. Vi è il rischio di soffocamento!
- ⚠ **OSTRZEZENIE** - Nie mocować do łóżka piętrowego żadnych lin, sznurów, pasów ani taśm, które mogłyby z niego zwisać, bo dzieci mogą się w nie zaplątać. Ryzyko uduszenia się!
- ⚠ **OPPOZORNENIE** - Laná, provazy, šňůry, opasky či pásky nemôžu byť pripravené alebo visieť dole z vysokej detskej postelky. Deti sa môžu zaplietť do nich. Hrozí nebezpečenstvo udusenía!
- ⚠ **ATENȚIE!** Nu legați ori atarnați funii, snururi, corzi, curele ori panglici de patutul înalt al copilului. Copiii se pot încurca în ele. Există riscul de sufocare!
- ⚠ **Внимание!** Не привязывать к верхней кровати ленты, веревки, пояса и т.д. Ребёнок может запутаться. Возможен риск удушья.



- Ⓛ Aufbauanleitung
- Ⓛ Notice de montage
- Ⓛ Handleiding voor de montage
- Ⓛ Montážní návod
- Ⓛ Szerelési útmutató
- Ⓛ Montaj talimatları

- Ⓛ Assembly instruction
- Ⓛ Istruzione di montaggio
- Ⓛ Instrukcja montażu
- Ⓛ Navod na montaž
- Ⓛ Instrucțiuni de montaj
- Ⓛ Инструкция по монтажу

37-0023-32-000

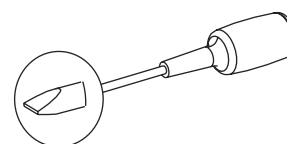
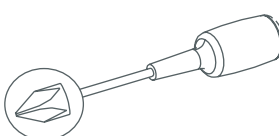
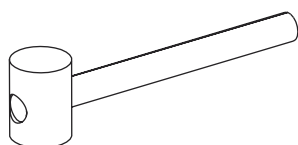
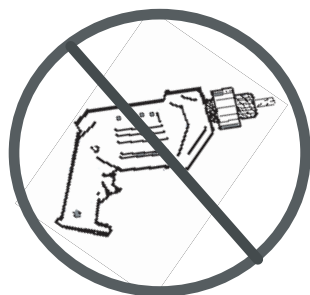
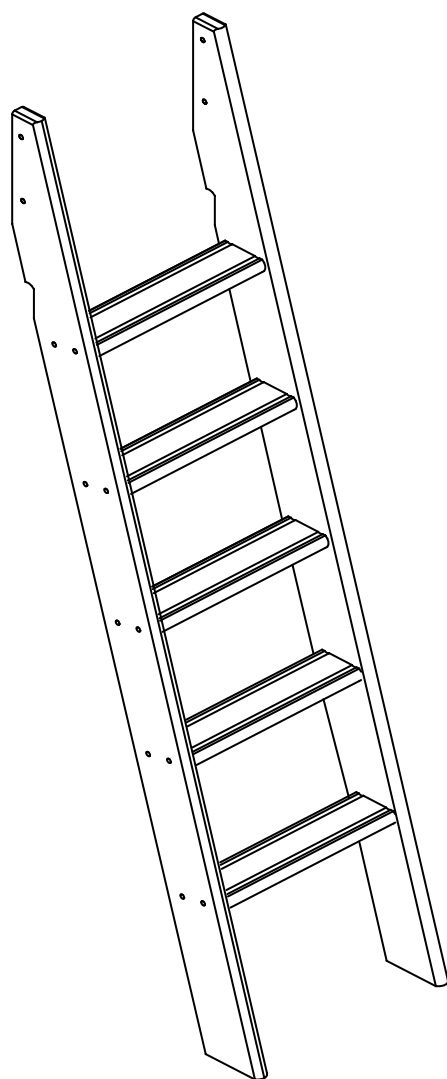

Product fullfil the standard "DIN EN 747-1:2015,DIN EN 747-2:2015"
 Produktet opfylder krav til standard "DIN EN 747-1:2015,DIN EN 747-2:2015"
 Produkt entspricht der Norm "DIN EN 747-1:2015,DIN EN 747-2:2015"
 Produit conforme au standard "DIN EN 747-1:2015,DIN EN 747-2:2015"

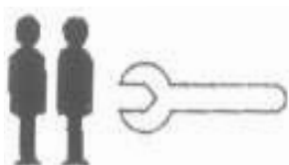

DIN EN 747-1:2015
DIN EN 747-2:2015

IMPORTANT-READ CAREFULLY AND RETAIN
WICHTIG-SORGFÄLTIG LESEN UND AUFBEWAHREN
VIGTIGT-LÆS grundigt igennem og opbevar
IMPORTANT-LIRE ATTENTIVEMENT ET A CONSERVER

Service • Assistenza • Dienstverlening • Serwis Servis • Szerviz • Сервисная служба

Name • Nom • Nome • Naam • Nazwa • Jméno • Názov
Név • Denumire • Isim • Название

Nr. • No. • N° • Č • Sz • Номер

Typ • Type • Tip • Tipus • Druh • Тіро • Тип

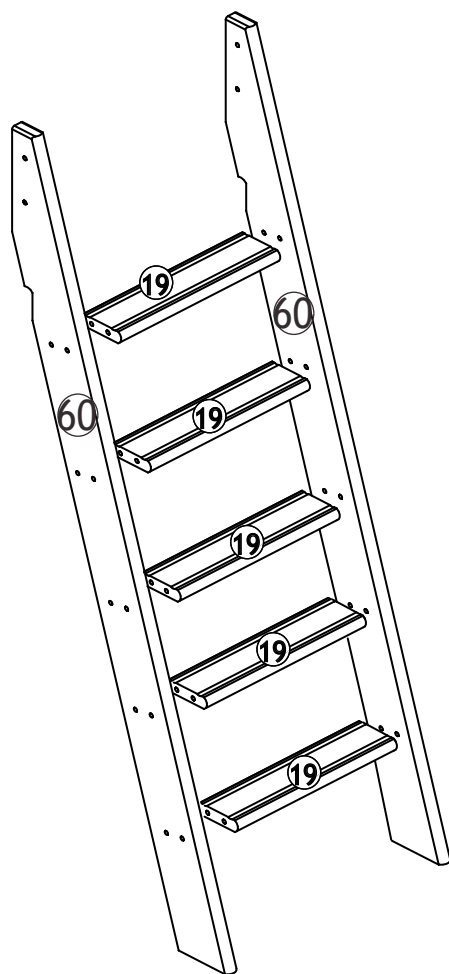
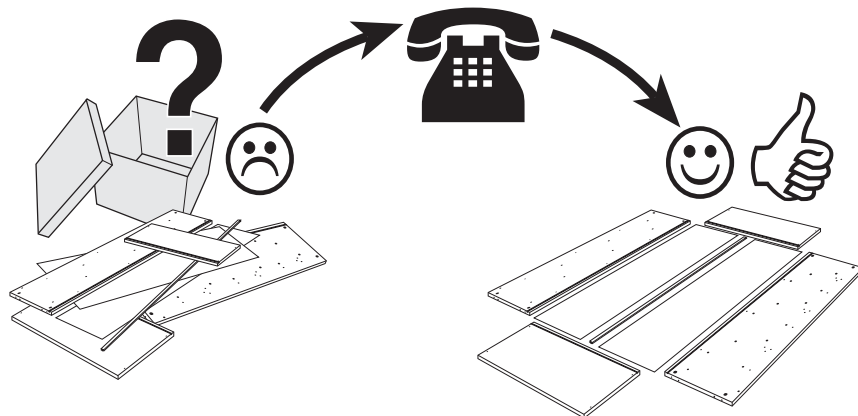
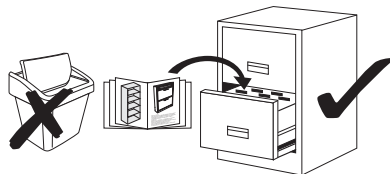

A.i. Nr.	Article Nr.	pcs
60	013118-32	x2
19	013018-32	x5

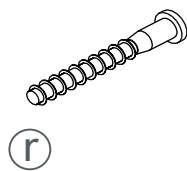
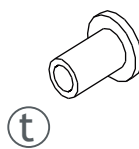
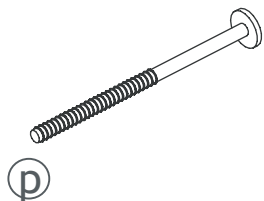
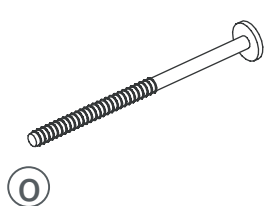
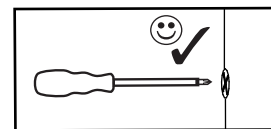
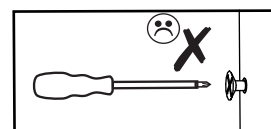
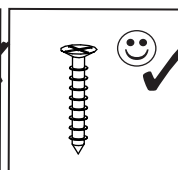
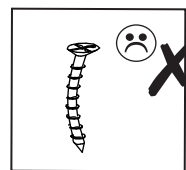

O	1-000025-07	M6x85	x2
P	1-000026-07	M6x120	x2
T	1-000027-07	8x15	x2
E	1-000014-57	8x13	x4
R	1-000028-07	7x60	x20
S	1-000029-07	4x50	x2

1-000001=

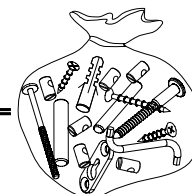

1.

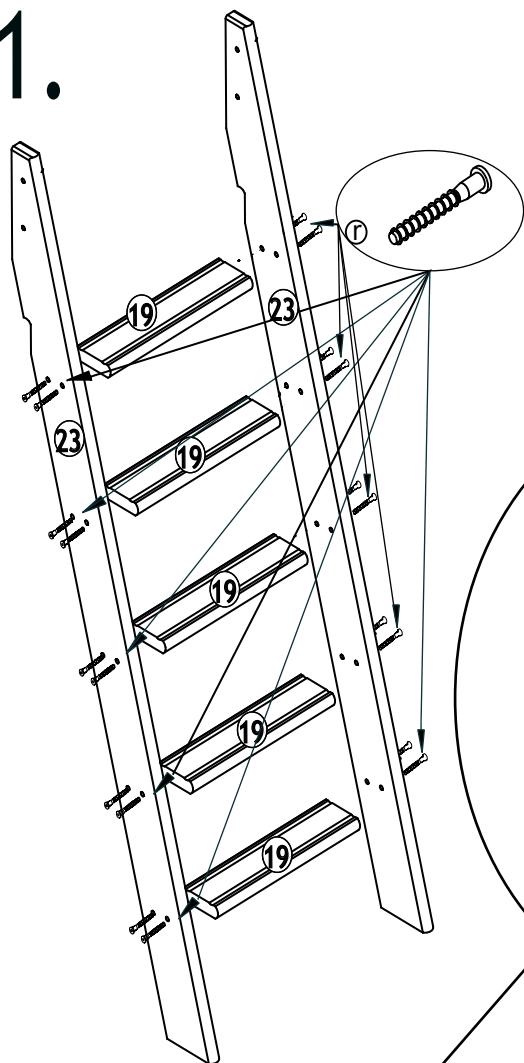

2.

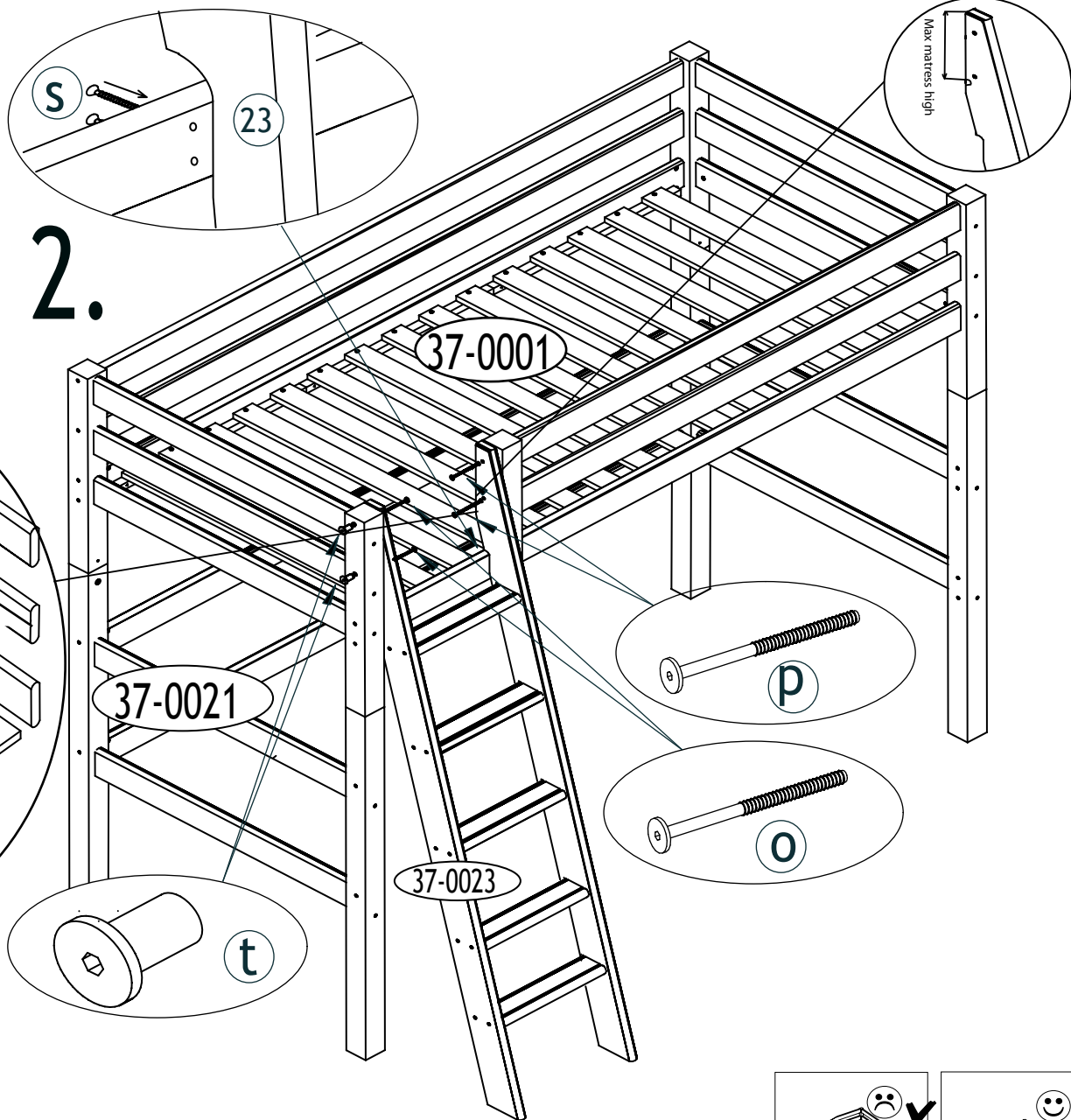

Ⓟ Maksymalna wysokość materaca

Ⓢ Značka maximálnej výšky matraca

Ⓡ Semnul nivelului maxim de inaltime a saltelei

Ⓡ Отметка для максимальной высоты матраса

DIN EN 747-1:2012

Ⓜ A maximális matracmagasság jelölése

Ⓡ Yatak minderinin gelebileceği en yüksek yer işareti

Ⓡ Mark of maximal mattress height level

Ⓡ Segno di massima altezza di livello del materasso

Ⓜ Markierung für die maximale Matratzenhöhe

Ⓡ Marque de la hauteur maximum du matelas

Ⓡ Markering van het maximale matrashoogte niveau

Ⓡ Značka maximální výšky matrace

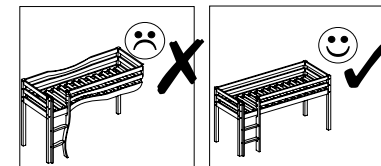

Close free holes with caps
 Luk alle huller med propper
 Schliessen Sie die offenen Löcher mit den Deckkappen
 Fermez les trous découverts avec les chapes



Die Anleitungen des Herstellers sind stets zu befolgen.

WARNHINWEIS „Hochbetten und das obere Bett von Etagenbetten sind für Kinder unter 6 Jahren aufgrund der Verletzungsgefahr durch Herabfallen nicht geeignet.“

WARNHINWEIS Das Etagenbett/Hochbett darf nicht benutzt werden, wenn ein konstruktives Bauteil beschädigt ist oder fehlt.

Die empfohlene(n) Matratzengröße(n) = 9x90x200cm ; 12x90x200cm.

Hinweis, dass eine ausreichende Raumbelüftung notwendig ist, um die Luftfeuchte niedrig zu halten und Schimmelbildung in und um das Bett zu verhindern.

Hinweis, dass der feste Anzug aller Verbindungselemente regelmäßig zu überprüfen ist.

WARNHINWEIS „Bei unsachgemäßem Gebrauch können Etagenbetten und Hochbetten eine ernste Verletzungsgefahr durch Strangulation darstellen. Gegenstände, die nicht für den Gebrauch mit dem Bett bestimmt sind, dürfen niemals an einem Teil des Etagenbettes befestigt oder aufgehängt werden, dies gilt z. B., aber nicht ausschließlich, für Seile, Schnüre, Kordeln, Haken, Gürtel und Taschen.“

WARNHINWEIS „Kinder können zwischen dem Bett und der Wand, einer Dachschräge, der Zimmerdecke, angrenzenden Einrichtungsgegenständen (z. B. Schränken) und usw. eingeklemmt werden. Um ernste Verletzungsgefahr zu vermeiden, darf der Abstand zwischen der Oberkante der Absturzsicherung und der angrenzenden Struktur 75 mm nicht überschreiten oder muss größer sein als 230 mm.“

UK WARNING

Always follow the manufacturer's instructions.

WARNING "High beds and the upper bed of bunk beds are not suitable for children under six years due to the risk of injury from falls"

WARNING Do not use the bunk bed/high bed if any structural part is broken or missing.

The recommended size of the mattresses = 9x90x200cm ; 12x90x200cm

A statement that ventilation of the room is necessary in order to keep the humidity low and to prevent mould in and around the bed.

A statement to check regularly that all assembly fastenings are properly tightening.

WARNING "Bunk beds and high beds can present a serious risk of injury from strangulation if not used correctly. Never attach or hang items to any part of the bunk bed that are not designed to be used with the bed, for example, but not limited to ropes, strings, cords, hooks, belts and bags."

WARNING "Children can become trapped between the bed and the wall, a roof pitch, the ceiling, adjoining pieces of furniture (e.g. cupboards) and the like. To avoid risk of serious injury the distance between the top safety barrier and the adjoining structure shall not exceed 75 mm or shall be more than 230 mm."

Die Anleitungen des Herstellers sind stets zu befolgen.

WARNHINWEIS „Hochbetten und das obere Bett von Etagenbetten sind für Kinder unter 6 Jahren aufgrund der Verletzungsgefahr durch Herabfallen nicht geeignet.“

WARNHINWEIS Das Etagenbett/Hochbett darf nicht benutzt werden, wenn ein konstruktives Bauteil beschädigt ist oder fehlt.

Hinweis, dass eine ausreichende Raumbelüftung notwendig ist, um die Luftfeuchte niedrig zu halten und Schimmelbildung in und um das Bett zu verhindern.

Hinweis, dass der feste Anzug aller Verbindungselemente regelmäßig zu überprüfen ist.

WARNHINWEIS „Bei unsachgemäßem Gebrauch können Etagenbetten und Hochbetten eine ernste Verletzungsgefahr durch Strangulation darstellen. Gegenstände, die nicht für den Gebrauch mit dem Bett bestimmt sind, dürfen niemals an einem Teil des Etagenbettes befestigt oder aufgehängt werden, dies gilt z. B., aber nicht ausschließlich, für Seile, Schnüre, Kordeln, Haken, Gürtel und Taschen.“

WARNHINWEIS „Kinder können zwischen dem Bett und der Wand, einer Dachschräge, der Zimmerdecke, angrenzenden Einrichtungsgegenständen (z. B. Schränken) und usw. eingeklemmt werden. Um ernste Verletzungsgefahr zu vermeiden, darf der Abstand zwischen der Oberkante der Absturzsicherung und der angrenzenden Struktur 75 mm nicht überschreiten oder muss größer sein als 230 mm.“

UK WARNING

Always follow the manufacturer's instructions.

WARNING "High beds and the upper bed of bunk beds are not suitable for children under six years due to the risk of injury from falls"

WARNING Do not use the bunk bed/high bed if any structural part is broken or missing.

A statement that ventilation of the room is necessary in order to keep the humidity low and to prevent mould in and around the bed.

A statement to check regularly that all assembly fastenings are properly tightening.

WARNING "Bunk beds and high beds can present a serious risk of injury from strangulation if not used correctly. Never attach or hang items to any part of the bunk bed that are not designed to be used with the bed, for example, but not limited to ropes, strings, cords, hooks, belts and bags."

WARNING "Children can become trapped between the bed and the wall, a roof pitch, the ceiling, adjoining pieces of furniture (e.g. cupboards) and the like. To avoid risk of serious injury the distance between the top safety barrier and the adjoining structure shall not exceed 75 mm or shall be more than 230 mm."

DK ADVARSEL

Følg altid producentens vejledninger.

ADVARSEL "Høje senge og den øverste køje af køjesenge er ikke egnet til børn under seks år grundet risiko for skader ved fald".

ADVARSEL Brug ikke køjesenge/høje senge hvis strukturelle dele mangler eller er ødelagte.

Udluftning af værelset er nødvendigt for at bevare en lav luftfugtighed og forhindre skimmel på og omkring sengen.

Kontroller regelmæssigt at alle samlinger er korrekt strammet.

ADVARSEL "Køjesenge og høje senge kan udgøre en alvorlig risiko for skader fra kvælning ved forkert brug. Hæng eller vedhæft aldrig genstande til nogen del af sengen, som ikke er designet til at blive brugt sammen med sengen for eksempel, men ikke begrænset til, reb, snor, ledninger, kroge, bæltter og tasker".

ADVARSEL "Børn kan blive fanget mellem sengen og væggen, en taghældning, loftet, tilstødende møbler (fx skabe) og lignende. For at undgå risiko for alvorlig skade bør afstanden mellem den øverste sikkerhedsbarriere og den tilstødende struktur være mindre end 75 mm eller være mere end 230 mm".